



Network
Components
Business Unit

Micro Batteries Product Catalogue

2002-2003

CMOS IC
Quartz Crystals
Micro Batteries

Materials
Liquid Crystal Display
Custom LCD Module

Seiko Instruments Inc.

Precautions for Your Safety

SII Lithium-ion rechargeable batteries (MS, RB, HB, TS) contain flammable organic solvents. For your safety, please follow following prohibitions.

Warning!

- **Do not charge by high current or high voltage.**
Doing so may generate gas inside the battery, resulting swelling, catching fire, heat generation or bursting.
- **Do not heat, disassemble nor dispose of in fire**
Doing so damages the insulation materials and may cause catching fire, heat generation, leakage or bursting.
- **Do not solder directly to the battery**
If soldering is performed directly to the battery, the battery is heated up, consequently causes leakage, explosion or fire due to overheating from internal short-circuiting.
- **Do not short.**
If the (+) and (-) come into contact with metal materials, short-circuiting occurs. As a result, catching fire, heat generation, leakage or bursting may occur.
- **Keep batteries out of children's reach.**
If leaked liquid is ingested or a battery is swallowed, consult a physician immediately.
- **Do not reverse placement of (+) and (-)**
If the (+) and (-) side of the battery is reverse inserted, it may cause a short-circuiting or over discharge of the battery on some equipment and it may induce overheating, explosion or fire.

- **Do not discharge by force**
If the battery is discharged by direct connection to an external power supply etc., voltage of the battery will decline lower than 0 volts (electrical reversal) and will cause the battery case to expand, overheat, leak, explode or burn.
- **In case of leakage or a strange-smell, keep away from fire to prevent ignition of any leaked electrolyte.**
- **In case of disposal, insulate between (+) and (-) of battery by an insulating**
Jumbling batteries or with other metal materials cause short-circuiting. As a result, catching fire, heat generation, leakage or bursting may occur.

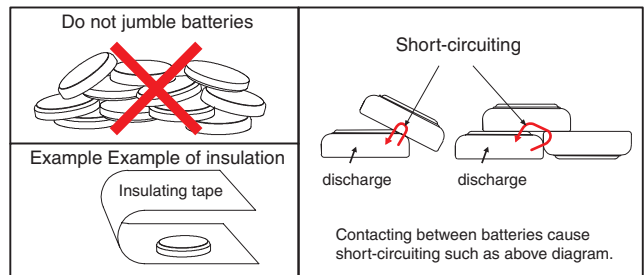

Caution!

- **If leaked liquid gets in the eyes, wash them with clean water and consult a physician immediately.**
- **Do not use new and used batteries together. Do not use different types of batteries together.**
It may cause catching fire, heat generation, leakage or bursting.
- **If you connect two or more batteries in series or parallel, please consult us in advance.**
It may cause bursting or catching fire due unbalanced load or voltage.
- **Do not use nor leave the batteries in direct sunlight nor in high-temperature areas.**
It may cause catching fire, heat generation, leakage or bursting.
- **Do not apply strong pressure to the batteries nor handle roughly.**
It may cause catching fire, heat generation, leakage or bursting.
- **Avoid contact with water.**
It may cause heat generation.
- **Keep batteries away from direct sunlight, high temperature and humidity.**
It may cause heat generation or performance deterioration.

For prevention the performance deterioration of battery

- **Pay attention to mat or sheet for ESD**
Battery with tabs or battery on PCB may short circuit on the mat for ESD. As a result the voltage of cell drops down.
- **Pay attention to soldering by tips**
Do no touch the battery by solder chips, in case of soldering another components after equipping battery. Basically, keep any high temperature process away from battery.
- **Pay attention to material of jig for pick and place**
Use nonconductive material of jig for pick and place of batteries, for short-circuit protect. If short circuit of battery is occurred, the voltage of battery drops down quickly but raises gradually.
- **Pay attention to washing and drying**
Some detergent or high temperature drying cause deterioration of battery. If you need to wash batteries, consult us.

International Transportation and Disposal

International Transportation

(Air Transport)

Based on DGR (Dangerous Goods Regulations) of ICAO (International Civil Aviation Organization), IATA (International Air Transport Association) has determined transport regulations. The regulation states that lithium batteries are considered not dangerous if they meet the following requirements;
Each bare cell with a solid cathode must contain 1.0g or less of lithium or lithium alloy.

They may be transported in rigid packaging with short-circuit protection.

The SII lithium-ion rechargeable batteries contain under 1.0g of lithium or lithium alloy per cell.

(Marine Transport)

IMO (International Marine Organization) has determined transport regulations based on IMDG (International Marine Dangerous Goods). The judgement standard of dangerous goods is based on DGR of ICAO. When the batteries are not regarded as dangerous goods, they should be transported in rigid packaging with short-circuit protection, according to IATA standards.

DOT (department of Transportation)

Regulations for packaging and transportation of lithium batteries in the U.S.A. are determined by Code 49 CFR173 185 of Federal Register.

The judgement standard of dangerous goods corresponds to DGR of ICAO. When the batteries are not regarded as dangerous, any transportation method is acceptable if they are transported in rigid packaging with short-circuit protection.

We will stick "Caution label" on outside of the shipping package to the U.S.A., please let us know if you need it.

Disposal

Recent environmental protection concerns have increased globally and waste and recycling are regulated in the world. The current regulations differ in each country, state and local municipality. Please consult local regulations and authorities for recommended disposal of batteries. If you are in question of application or safety of our batteries, please consult your local authorities.

Precautions for Your Safety

SII capacitors (XC, XH) contain flammable organic solvents. For your safety, please follow following prohibitions.

Warning!

- **Do not charge by high current or high voltage.**
Doing so may generate gas inside the capacitor, resulting swelling, catching fire, heat generation or bursting.
- **Do not reverse placement of (+) and (-)**
SII capacitors have polarity. If the (+) and (-) side of the capacitor is reverse inserted, it may cause a short-circuiting or over discharge of the capacitor on some equipment and it may induce overheating, explosion or fire.
- **Do not solder directly to the capacitor**
If soldering is performed directly to the capacitor, the capacitor is heated up, consequently cause leakage, explosion or fire due to overheating from internal short-circuiting.
- **Keep capacitors out of children's reach.**
If leaked liquid is ingested or a capacitor is swallowed, consult a physician immediately.
- **Do not heat, disassemble nor dispose of in fire**
Doing so damages the insulation materials and may cause catching fire, heat generation, leakage or bursting.
- **Do not discharge by force**
If the capacitor is discharged by direct connection to an external power supply etc., voltage of the capacitor will decline lower than 0 volts (electrical reversal) and will cause the capacitor case to expand, overheat, leak, explode or burn.
- **In case of leakage or a strange-smell, keep away from fire to prevent ignition of any leaked electrolyte.**

Caution!

- **If leaked liquid gets in the eyes, wash them with clean water and consult a physician immediately.**
- **Do not use nor leave the capacitors in direct sunlight nor in high-temperature areas.**
It may cause catching fire, heat generation, leakage or bursting.
- **Do not use new and used capacitors together. Do not use different types of capacitors together.**
It may cause catching fire, heat generation, leakage or bursting.
- **If you connect two or more capacitors in series or parallel, please consult us in advance.**
It may cause bursting or catching fire due unbalanced load or voltage.
- **Keep capacitors away from direct sunlight, high temperature and humidity.**
It may cause heat generation or performance deterioration.

Precautions for Your Safety

For using SII Silver Oxide batteries, please follow following prohibitions.

Warning!

- **Do not heat, disassemble nor dispose of in fire**
Doing so damages the insulation materials and may cause catching fire, heat generation, leakage or bursting.
- **Do not short.**
If the (+) and (-) come into contact with metal materials, short-circuiting occurs. As a result, catching fire, heat generation, leakage or bursting may occur.
- **Keep batteries out of children's reach.**
If leaked liquid is ingested or a battery is swallowed, consult a physician immediately.
- **If leaked liquid, alkaline, get in the eyes, do not rub them, wash them with clean water and consult a physician immediately.**
- **If leaked liquid, alkaline, stick upon wears, for protecting irritation, wash them with clean water immediately.**

Caution!

- **Do not reverse placement of (+) and (-)**
- **Do not solder directly to the battery**
- **Do not use new and used batteries together. Do not use different types of batteries together.**
- **Do not charge.**
- **Do not use nor leave the batteries in direct sunlight nor in high-temperature areas.**
- **Keep batteries away from direct sunlight, high temperature and humidity.**
- **Avoid letting battery contact with water.**
- **Make sure to insert batteries without having (+) and (-) come in contact with metal parts of equipment.**
- **Read the equipment instruction manual and precautions carefully before use. Some usage or types of equipment do not suit the specifications or performance of these batteries.**
- **Remove batteries from the equipment, if finish using. Do not leave batteries connecting with equipment after using.**
- **In case of disposal, insulate between (+) and (-) of battery by an insulating**



GENERAL DESCRIPTION

Seiko Instruments Inc. has commercialized a highly reliable silver oxide battery in response to quartz watches. Since then the company has expanded its microbattery business. With rapid progress in LSI technologies, highly advanced microbatteries are now being strongly demanded for sophisticated electronic instruments and equipment. The company continues its best efforts to develop high performance microbatteries which meet any users' needs and requirements.

This brochure introduces silver oxide batteries, manganese silicon lithium-ion rechargeable batteries, titanium silicon lithium-ion rechargeable batteries, reflowable capacitors, and reflowable lithium-ion rechargeable batteries.

We would like to continuously develop higher performance micro battery and widen product lineup. Please feel free to contact us.

CONTENTS

Safety Precautions for handling Battery and Capacitor	2
Lineup of Micro Batteries and Capacitors	5
MS Lithium-Ion Rechargeable Battery	6
Battery Holder	11
Reflowable RB lithium-Ion Rechargeable Battery	12
Pb-free reflowable HB lithium-Ion Rechargeable Battery ...	14
TS Lithium-Ion Rechargeable Battery	16
Reflowable XC Capacitor (2.5V Rated Voltage Type)	18
Reflowable XH Capacitor (3.3V High-Rated Voltage Type)	20
Pb-free reflowable XHxxH Capacitor (3.3V Rated Voltage type)	22
Silver Oxide Battery	24
SII GROUP ENVIRONMENTAL POLICY	26
Check Sheet for Selecting Micro Battery	27

FEATURES

1. Superior leakage resistance

Electrolytic leakage may lower the contact with terminals of the electronic instruments which use microbatteries. This interrupts the stable operations. Special sealing materials and processing technologies are employed in the manufacture of our batteries.

2. Large capacity

In order to extend the operating time of the machinery and equipment with-in the limited battery space, batteries need large capacity.

Our microbatteries have large capacity. It is obtained by our original design technologies and by use of high purity materials.

3. Stable operating voltage

The battery Voltage depends on the temperature and the depth of discharge. Since the change of the voltage affects characteristics of machinery and equipment, the operating voltage must be stable.

Our microbatteries have a stable operating voltage over a wide temperature range and in a depth of discharge.

4. High reliability

Batteries are required to have high performance in any event, that is, high reliability.

Our microbatteries are manufactured under our high quality control.

Only batteries with high quality are delivered to customers.

Lineup of Micro Batteries and Capacitors

Features of Micro Battery and Capacitor

- MS Series** : 3V Type. Obtains small size, large capacity and highly long cycle life. Also superior in Over-discharge characteristics.
- RB Series** : Reflowable rechargeable battery with wide charging voltage range (1.8V to 3.3V).
- HB Series** : Pb-free reflowable rechargeable battery with wide charging voltage range (1.8V to 3.3V). <New Product>
- TS Series** : 1.5V Type. Wide charging voltage range from 1.5V to 3.0V with high reliability.
- XC Series** : Smallest and thinnest size in reflowable capacitor with a rated voltage of 2.5V.
- XH Series** : Reflowable capacitor obtaining both high rated voltage of 3.3V and high energy density.
- XH xx H Series** : Pb-free reflowable capacitor obtaining both high rated voltage of 3.3V and high energy density. <New Product>
- SR Series** : Wide variation of products which obtain high reliability gained through our watch Production.

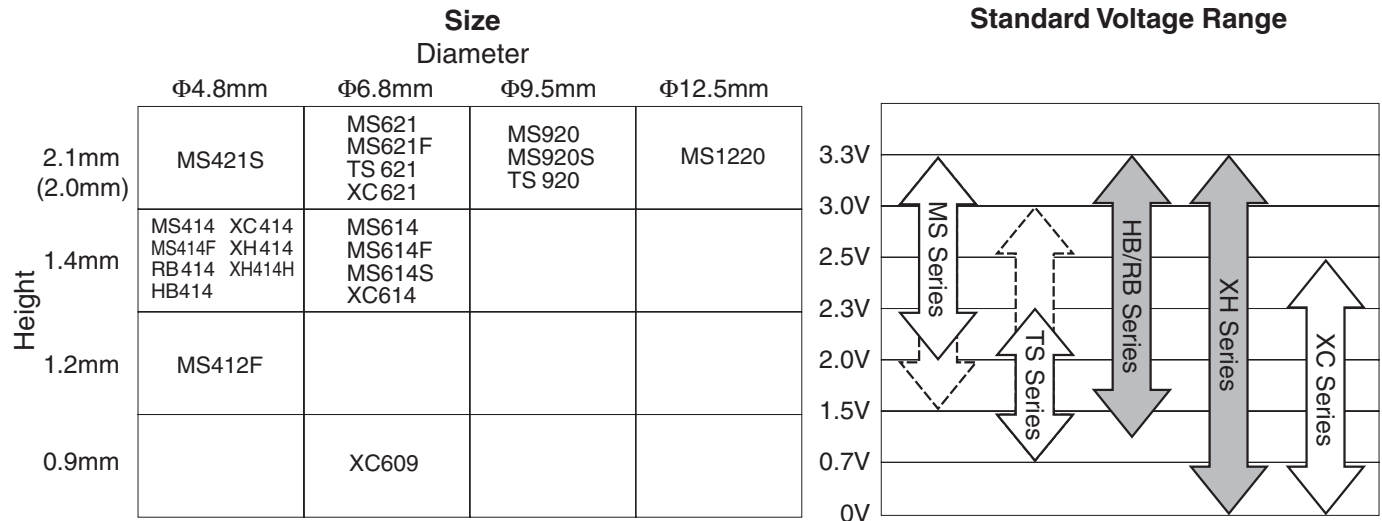

Fitting List by Applications

Usage	Application	SR	TS	MS	RB/HB	XC	XH	Necessary Features
Backup use	GSM		○	○	○	○	○	Long cycle life and Over-discharge
	PDC/CDMA		○	○				Small and Large capacity
	Telephone				○	○	○	Long cycle life and large capacity
	Digital Camera				○	○	○	Long cycle life
	VCR Camera				○			Long cycle life and large capacity
	Camera					○	○	Long cycle life and Over-discharge
	TV/VTR				○	○	○	Long cycle life
	GPS				○	○	○	Long cycle life
	PDA				○	○	○	Large capacity
	Personal Computer				○			Large capacity
	FAX				○	○	○	Long cycle life and large capacity
	PC Card				○	○	○	Long cycle life
	Long time backup				○	○		Large capacity
	Short time backup				○	○	○	Long cycle life
Power Supply	Watch	○	○			○		Large capacity and small self-discharge, Over-discharge, stable.
Battery Type		Main	Recharge-able	Recharge-able	Recharge-able	Capaci-tor	Capaci-tor	

MS Lithium-Ion Rechargeable Battery <3V Type>

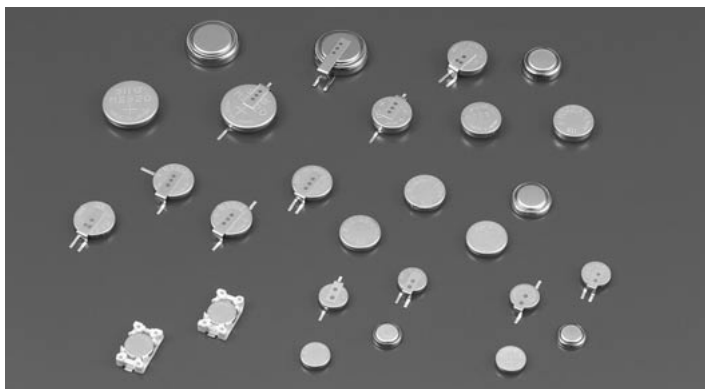

SII own developed MS(Manganese Silicon) Lithium-ion rechargeable battery addresses the demand most effectively. The battery uses silicon oxide as anode and lithium manganese composite oxide as cathode. As a result, it offers twenty times the capacity of conventionally available batteries, in addition to longer cycle-life and highly stable over-discharge characteristics.

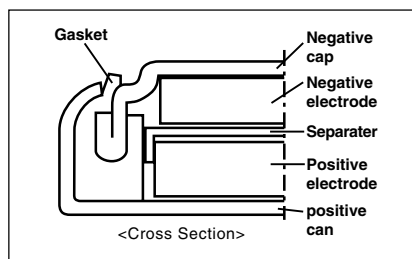

FEATURES

- Large discharge capacity:
Large discharge capacity for high operational voltage range of 2.0V to 3.3V.
- Long cycle-life:
Over 200 times cycle-life under the charge/discharge condition at 2.0V to 3.3V (D.O.D 100%).
- Excellent over-discharge characteristics:
Continued stable capacity characteristics after the battery is over-discharged down to 0.0V.
- Approved product by UL

Manganese Silicon Lithium-ion Battery (MS series) is approved by UL(Underwriters Laboratories Inc.)

UL File MH 15628

MS412F/MS414/MS614/MS614F/MS614S/
MS621/MS621F/MS920/MS920S/ (MS421S)

APPLICATIONS

- Back up power supply for memory or clock in various electronic equipment e.g. cellular-phones, cordless phones, PHS, pagers, memory-cards, FAX machines, personal computers, PDA, Video cameras, digital cameras, tuners, handy terminals etc.
- Combined use with solar cells.
- Main power source for small and slim portable equipment.

SPECIFICATIONS

Type	Nominal Voltage (v)	Nominal Capacity (mAh)	Internal Resistance (Ω)*1	Standard Charge/Discharge Current (mAh)	Maximum Discharge/Current (continuous) (mA)*2	Cycle Life (Times)*3		Standard Charge Voltage (V)	Size(mm)		Weight (g)
						100% D.O.D (Depth of Discharge)	20% D.O.D (Depth of Discharge)		Diameters	Height	
MS412F	3	1.0	100	0.010	0.15	200	1000	3.1	4.8	1.2	0.07
MS414	3	0.25	100	0.010	0.15	200	1000	3.3	4.8	1.4	0.07
MS414F	3	1.2	100	0.005	0.15	200	1000	3.1	4.8	1.4	0.07
New MS421S	3	2.5	160	0.010	0.15	100	1000	3.1	4.8	2.1	0.11
MS614	3	2.3	50	0.025	0.50	200	1000	3.3	6.8	1.4	0.17
MS614F	3	3.0	80	0.025	0.50	200	1000	3.1	6.8	1.4	0.16
MS614S	3	3.4	80	0.025	0.50	200	1000	3.1	6.8	1.4	0.17
MS621	3	4.0	50	0.025	0.50	200	1000	3.3	6.8	2.1	0.23
MS621F	3	5.5	80	0.025	0.50	200	1000	3.1	6.8	2.1	0.23
MS920	3	8.0	35	0.050	1.00	200	1000	3.3	9.5	2.1	0.46
New MS920S	3	11.0	35	0.050	0.80	100	1000	3.1	9.5	2.1	0.47
Developing MS1220S	3								12.5	2.0	

*1 Internal resistance is measured using AC (Alternating Current) method.

(24°C, 3.3V to 2.0V / 3.1V to 2.0V(F, S type))

*2 Maximum discharge current indicates the value of current for approximately 50% of nominal capacity.

*3 100% and 20% D.O.D are based on nominal capacity.

Principle System of MS Lithium-Ion Rechargeable Battery

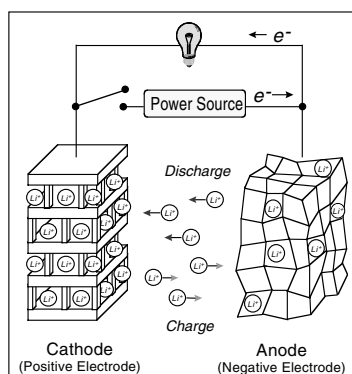

Anode (negative electrode) Lithium silicon composite oxide developed by SII in our MS battery is :

- ① able to absorb a large quantity of Lithium ions.
- ② stable during Absorption (charging) and Release (discharging) of the Lithium ions

1. High Capacity

2. Long Cycle Life

More than 200 times cycle life under D.O.D (Depth of Discharge) 100%

3. Overdischarge Characteristics

Discharge Characteristics at Various Charge Voltage

MS412F

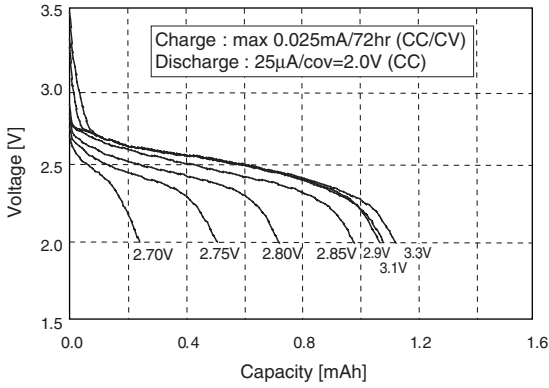

MS421S

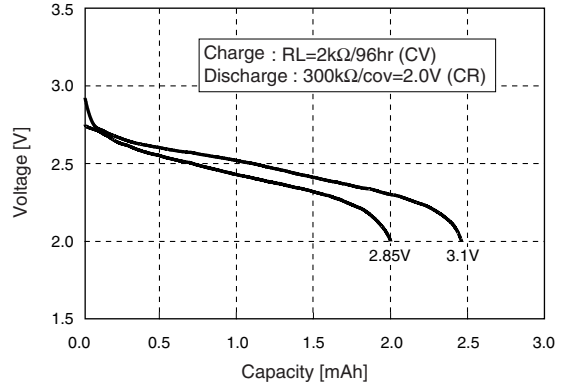

MS614

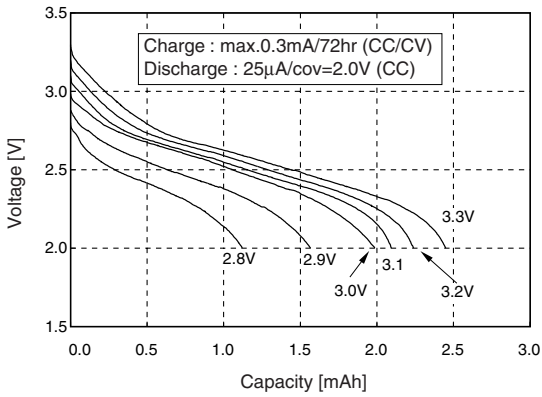

MS614S

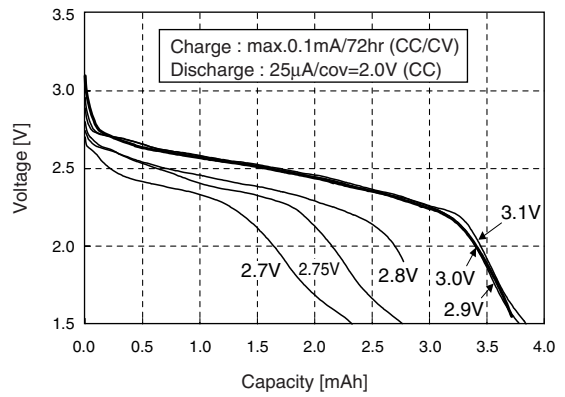

MS621

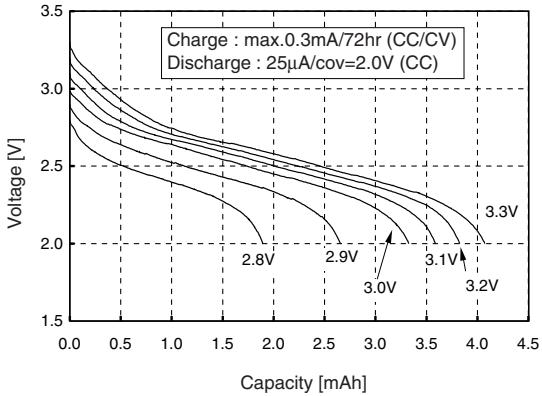

MS621F

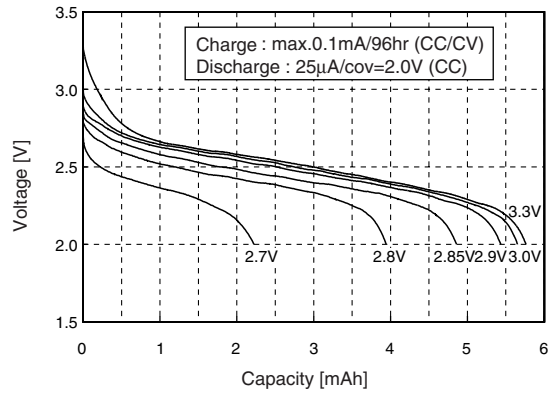

MS920

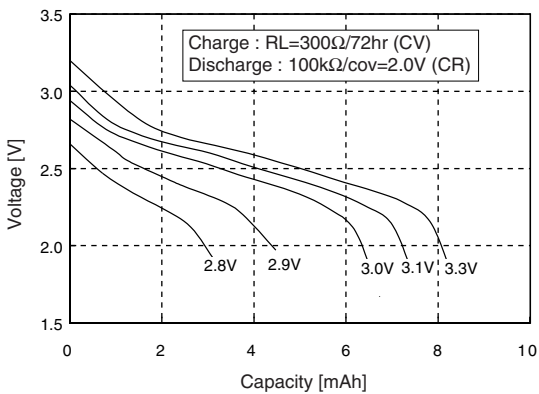

MS920S

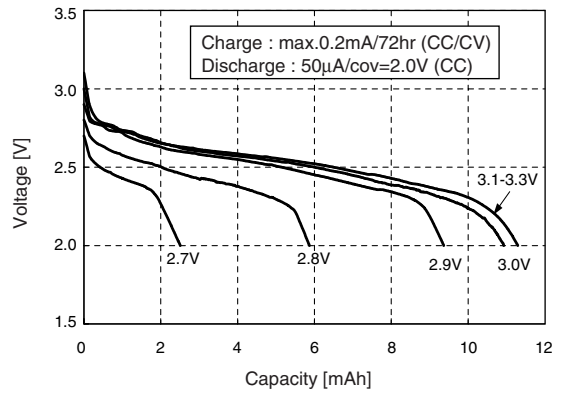

MS Lithium-Ion Rechargeable Battery <3V Type>

CHARACTERISTICS

MS621

Cycle Life-Depth of Discharge

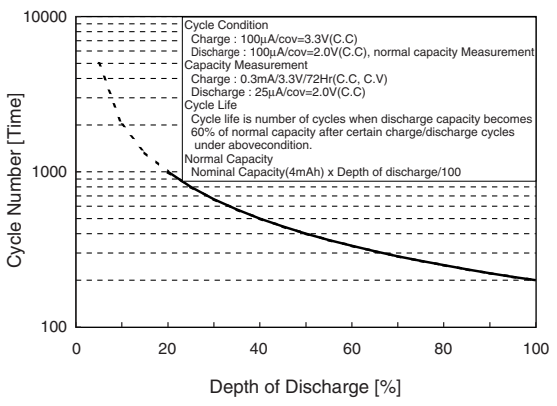

High Temperature Storage Characteristics(80°C)

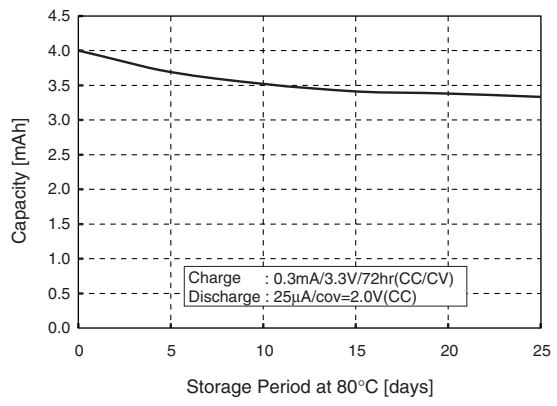

High Temperature Storage Characteristics(60°C)

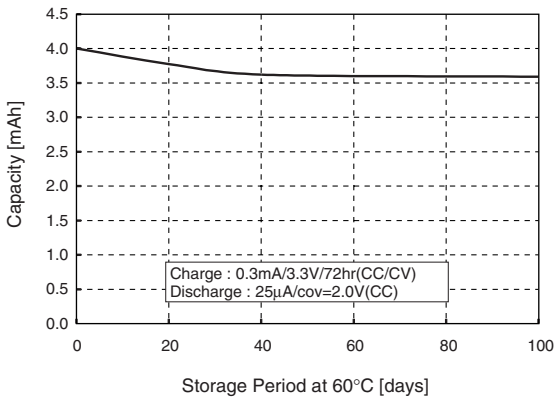

Over Discharge Characteristics

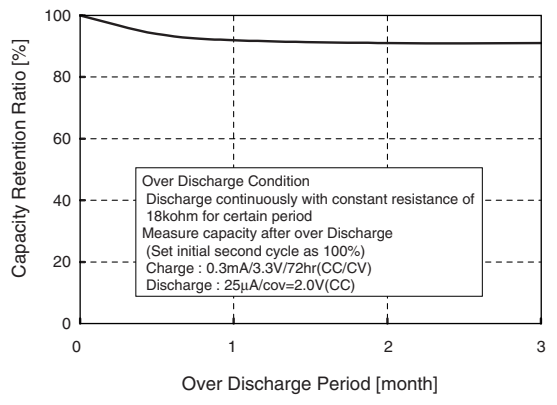

Over-Charge (Floating-Charge) Characteristics

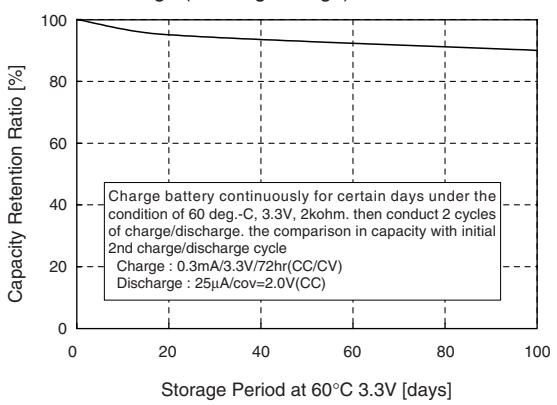

Self Discharge Characteristics

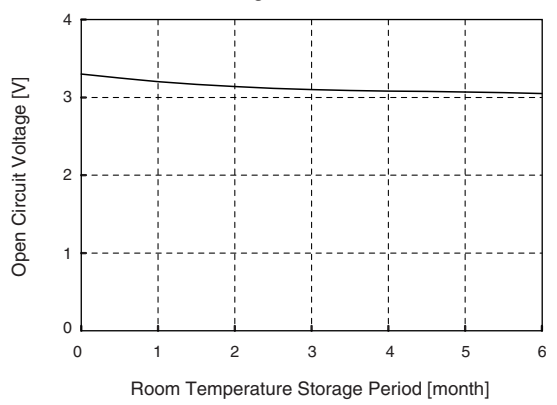

Temperature Characteristics (Capacity)

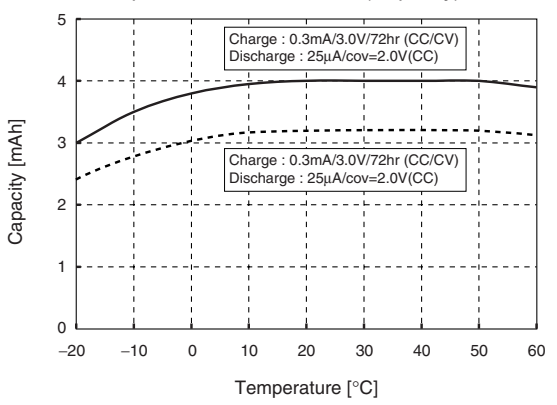

Temperature Characteristics (Internal Resistance (Ri ac))

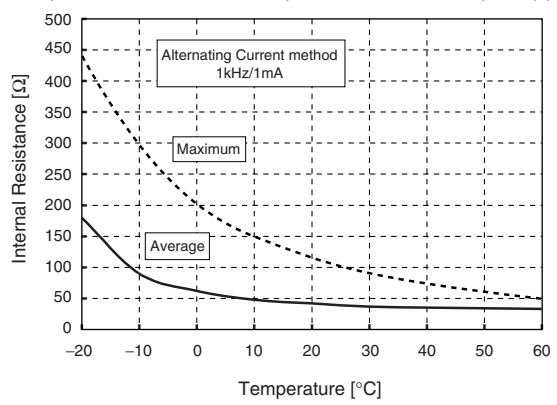

MS Lithium-Ion Rechargeable Battery <3V Type>

CHARGING CIRCUIT

◆ Standard Charging Circuit Settings List for Using MS Rechargeable Battery with Constant Voltage and Constant Resistance.

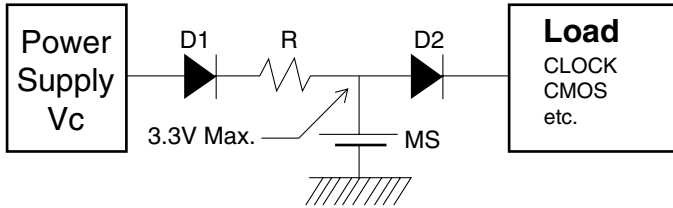

Charging Voltage : 3.3V Max.
 Charging current limiting resistance : R
 D1 : Diode (Item of smaller VF, IR is recommendable)
 D2 : Using a schottky type of smaller VF will lead better performance

Type	Charging Voltage Range (V)	Recommendable Charging Current (mA) At Battery Voltage of 3.0V I_c	Maximum Charging Current (mA)	
			At the Battery Voltage of 3.0V I_u	At the Battery Voltage of 0V I_L
MS412F	2.7 to 3.3	0.08max.	0.15	2
MS414	2.7 to 3.3	0.08max.	0.15	2
MS421S	2.7 to 3.3	0.08max.	0.15	2
MS614, 614F, 614S	2.7 to 3.3	0.30max.	0.5	10
MS621, 621F	2.7 to 3.3	0.30max.	0.5	10
MS920	2.7 to 3.3	0.60max.	1.0	20
MS920S	2.7 to 3.3	0.40max.	0.5	10

As for the minimum limit resistance R, please use the value which satisfies the following two formula;
 1) In the case a battery voltage is 3.0V:
 $R > (V_c - 3.0 - V_f) / I_u$
 2) In the case a battery voltage is 0V:
 $R > (V_c - V_f) / I_L$
 Also for the recommendable limit resistance, please use I_c instead of I_u in the formula 1).

◆ Circuit Example in the case of using 3V for Power Supply.

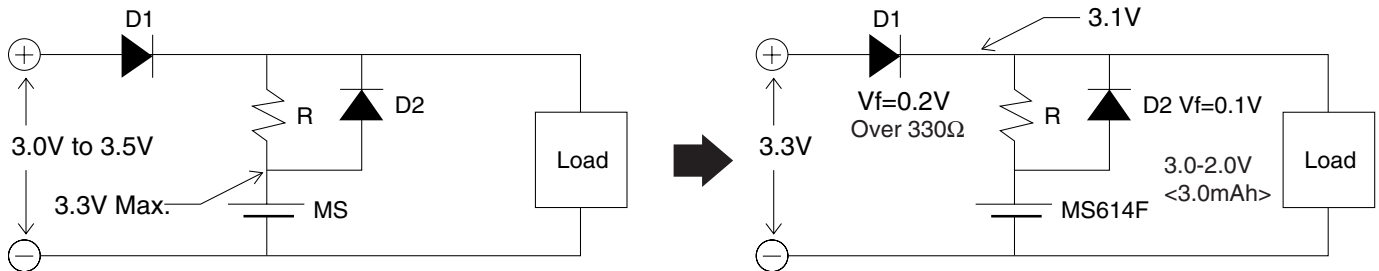

◆ Circuit Example in the case of using 5V for Power Supply.

(1) with using voltage regulator IC

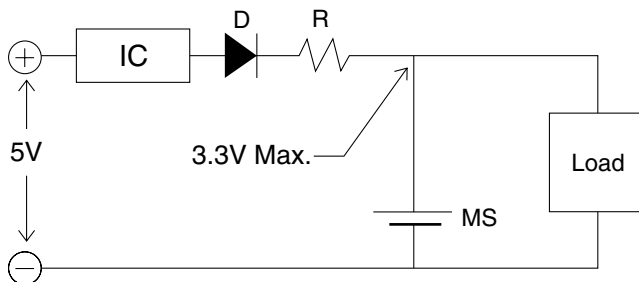

(2) with using Zener diode

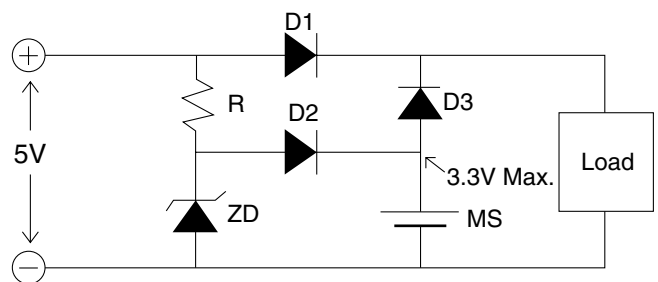

(3) with using charge/discharge control IC

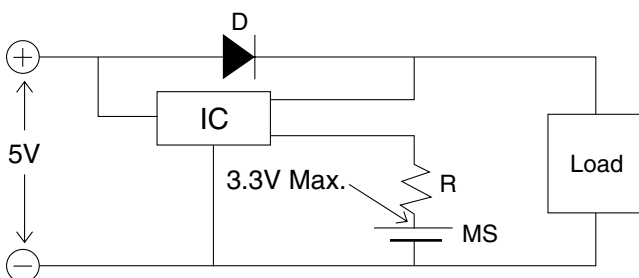

(4) with using divided resistance for voltage

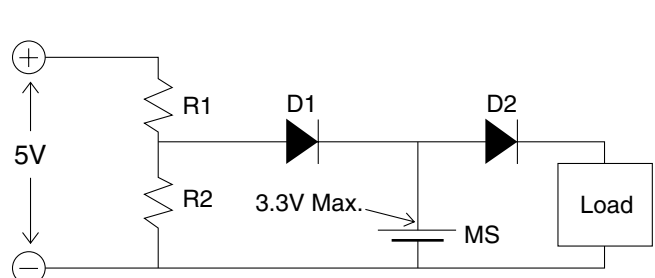

MS Lithium-Ion Rechargeable Battery <3V Type>

■ DIMENSIONS OF STANDARD TAB-WELD FOR MANGANESE SILICON LITHIUM-ION BATTERY

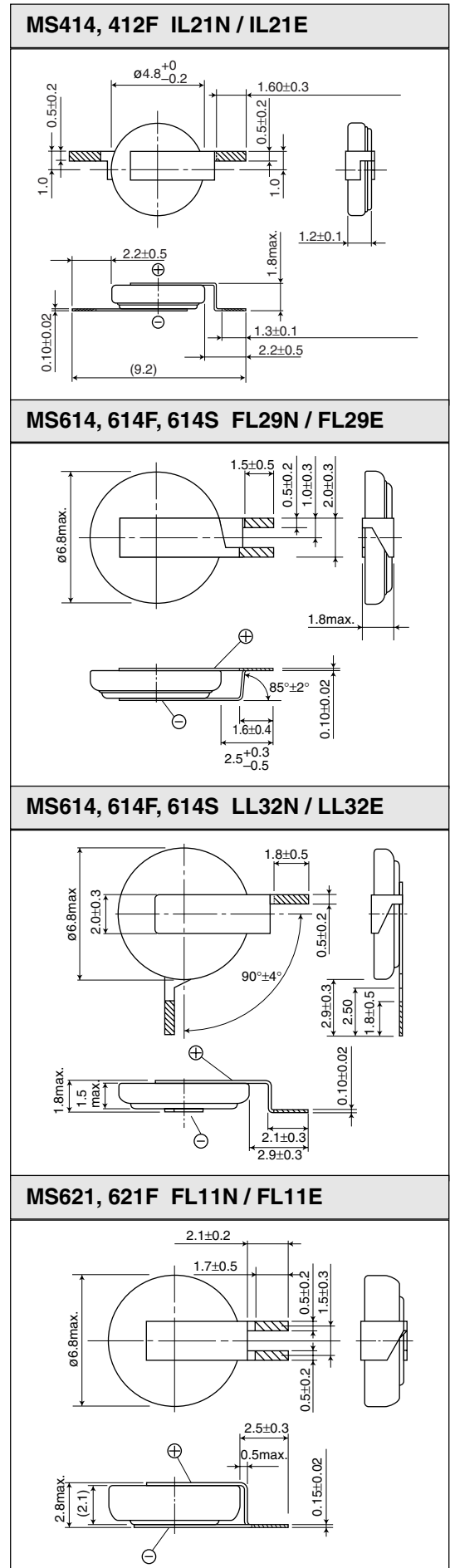
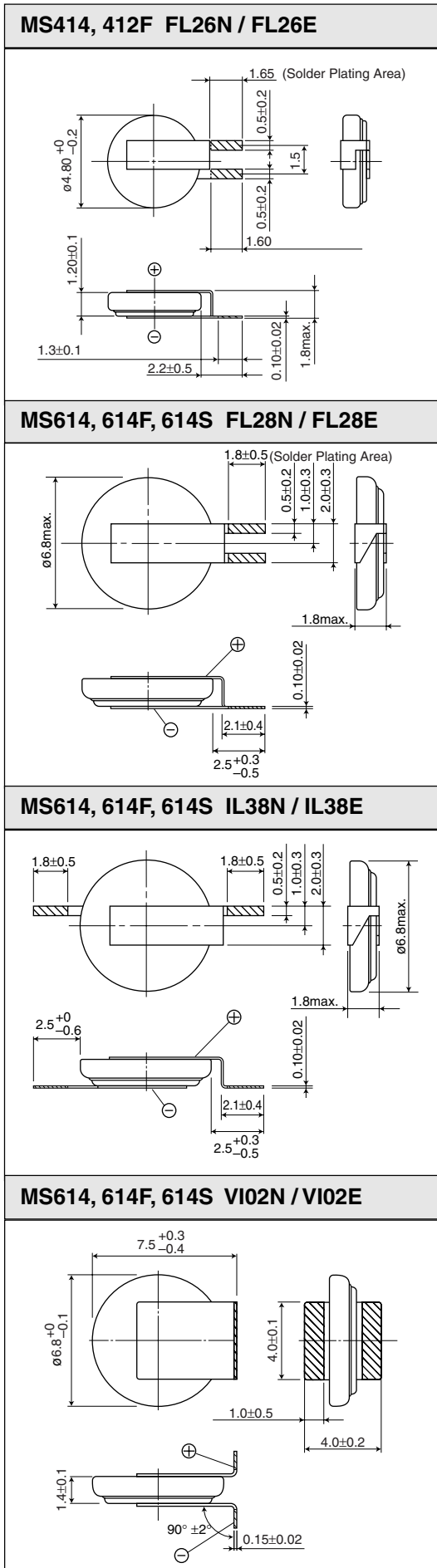

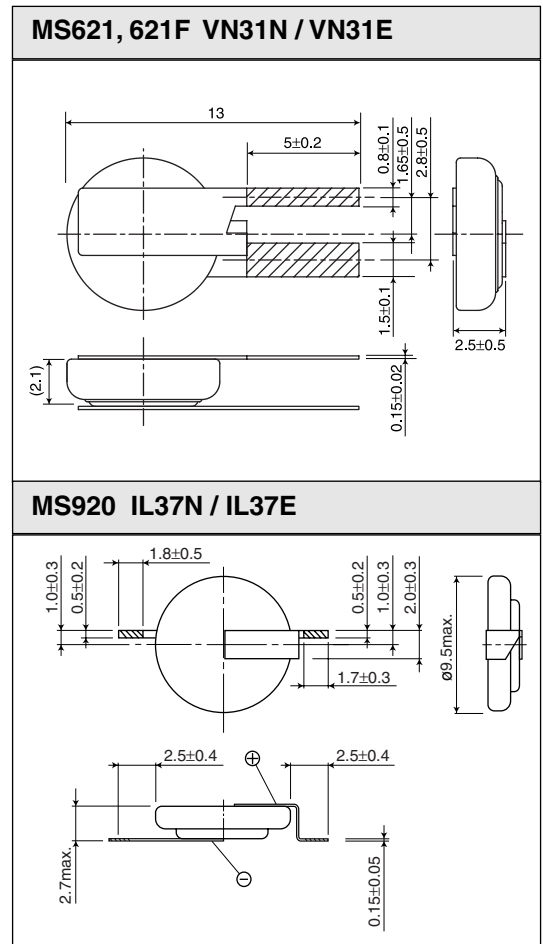
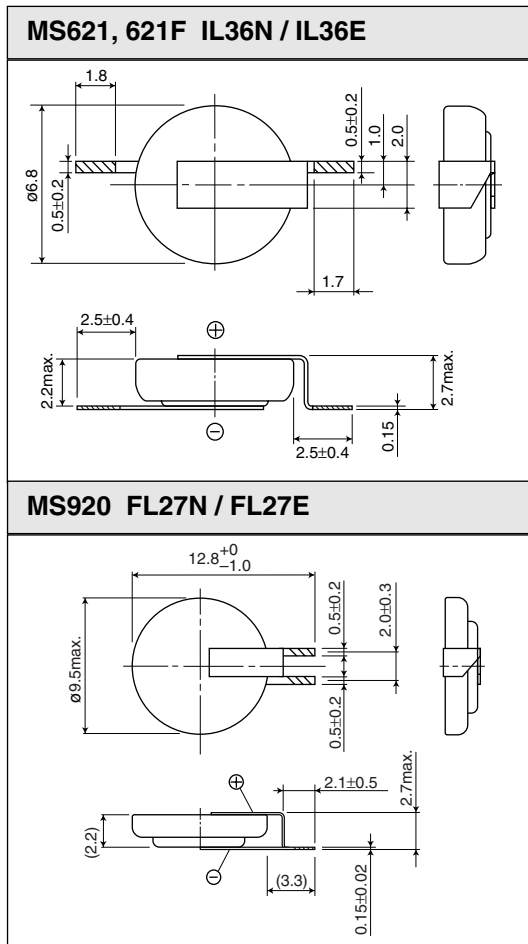

- Hatched parts are solder plated. (N type: Pb 10% Sn 90%) (E type: Sn 100%)
- The E type is plated by Pb-free solder. We are going to discontinue N type soon.
- For any optional terminal shapes, please consult with us.
- Unit of dimensions: mm

BATTERY HOLDER

BH0414

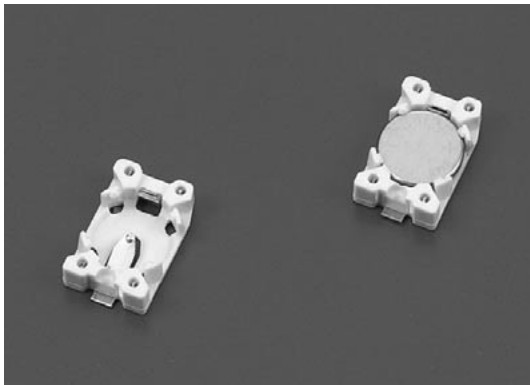

Using precision technology the holder realizes less-space and high reliability and obtains high mounting functionality.

<Specifications>

Item	Standard
With Standing Voltage	DC500V/minute
Contact Resistance	Less than 100mΩ
Insulation Resistance	More than 100MΩ
Operational Temperature Range	-40°C ~ +85°C

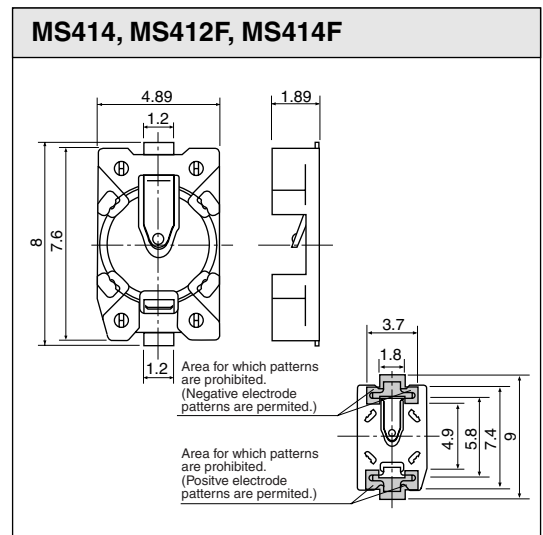

<Applicable Batteries>

MS414, MS412F, MS414F

<Features>

- Thin: 1.89mm Height after mounting
- Easy for Automatic mounting:
Able to insert battery vertically
- Embossed Tape Package

Reflowable RB Lithium-Ion Rechargeable Battery



FEATURES

- Reflowable : Superior heat resistance without deterioration of battery performance due to reflow soldering.
- Wide Range of charging voltage : Wide range voltage (1.8V to 3.3V) allows to be used for various applications
- High Capacity : Ten times higher than capacitor in 0.3mAh typ. (charge:3V cut off 1.2V)
- Long cycle life : More than 1,000 times charge/discharge cycle (10% D.O.D)
- Excellent over discharge characteristics

APPLICATIONS

Power supply back up use for Cellular phone, Wireless phone, PHS, Digital still Camera, PDA, MD player.

RB Lithium-Ion rechargeable battery allows reflow soldering for automatic mounting, by adopting highly heat-resistant material and precise sealing technology. RB Series features high capacity and long cycle life with possible charging voltage range from 1.8V to 3.3V, which is most suitable for backup use of real time clock and SRAM etc.

SPECIFICATIONS

Type	Nominal Voltage (V)	Nominal Capacity (Voltage Range) (mAh)	Standard Charge Discharge Current (mA)	Cycle Life (Time)	Diameter (mm)	Height (mm)	Weight (g)
RB414	3.0	0.3 (3.0-1.2) 0.2 (2.5-1.2) 0.14 (3.0-2.0)	0.005	1000 (10% D.O.D) 100 (100% D.O.D)	4.8	1.4	0.07

CHARACTERISTICS

Charge-Discharge Characteristics

1. 3.3V

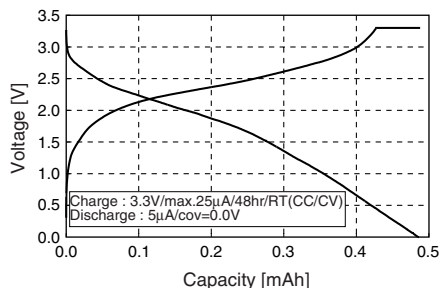

2. 3.0V

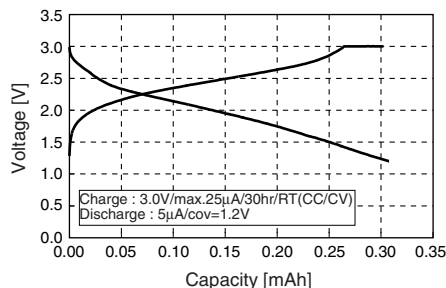

3. 2.5V

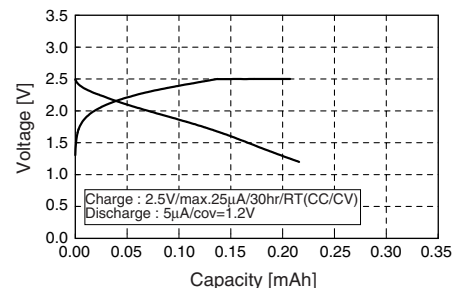

CHARACTERISTICS

Charge-Discharge Cycle Characteristics (100% D.O.D)

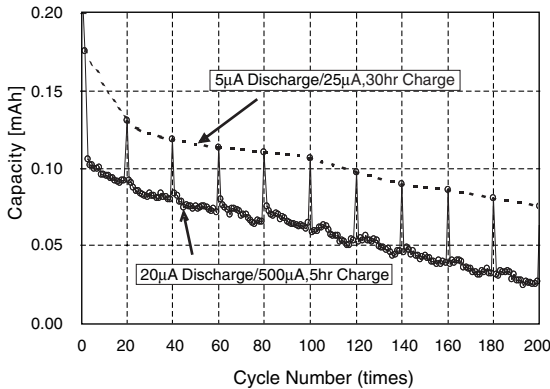

High Temperature Storage Characteristics (60°C)

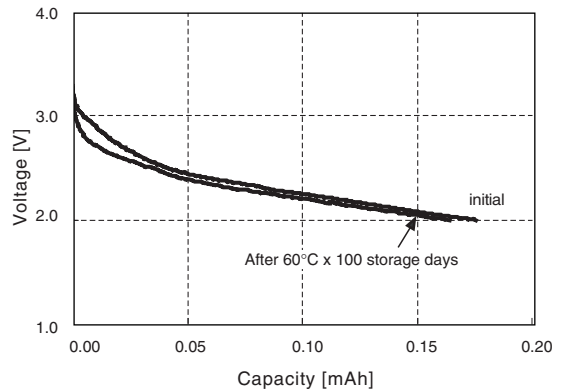

REFLOW SOLDERING CONDITION

Reflow Soldering Temperature Profile Example

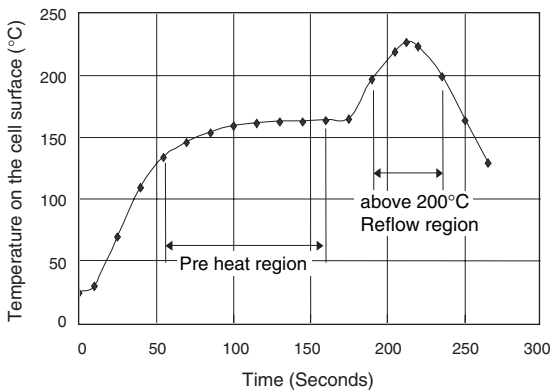

The times of repeated reflow soldering must be two times or less.
The Temperature must be measured at top of the cell.

Recommended Reflow Condition

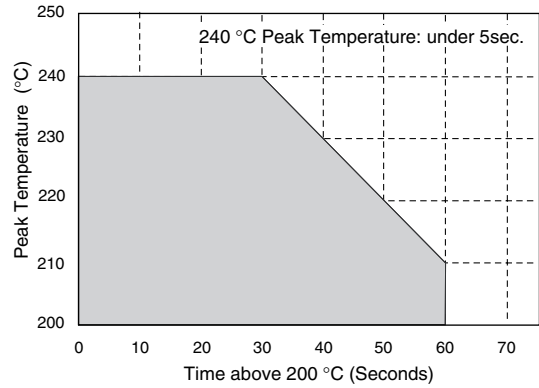

DIMENSIONS OF STANDARD TAB-WELD FOR REFLOWABLE RB BATTERY

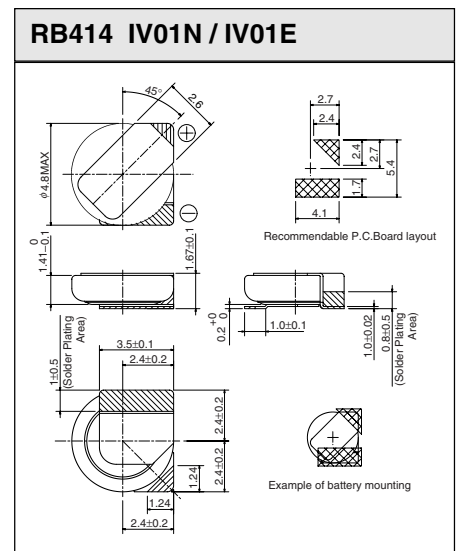
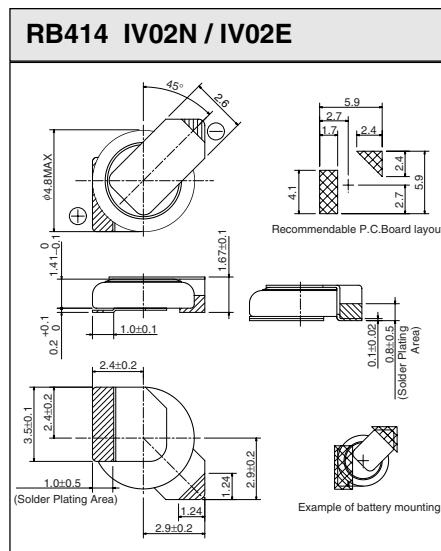
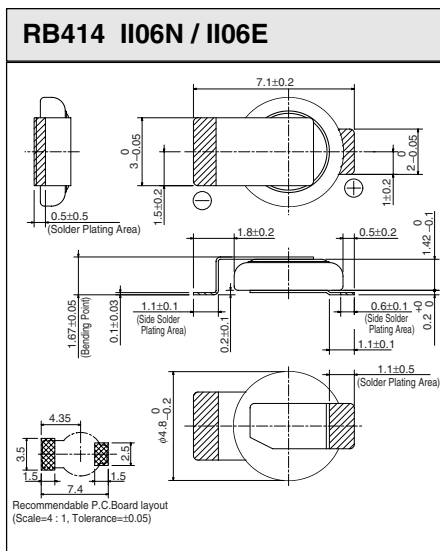

- * Hatched parts are solder plated. (N type : Pb 10% Sn 90%) (E type : Sn 100%)
- * The E type is plated by Pb-free solder. We are going to discontinue N type soon.
- * For any optional terminal shapes, please consult with us.
- * Unit of dimensions : mm

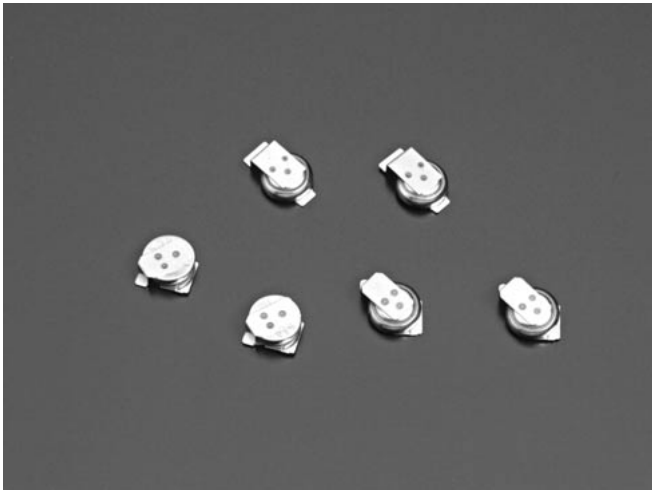

FEATURES

- Pb-free reflowable
Superior heat resistance (260°C peak) allows reflow soldering by Pb-free solder.
- Wide Range of charging voltage : Wide range voltage (1.8V to 3.3V) allows to be used for various applications
- High Capacity :
Ten times higher than capacitor in 0.3mAh typ. (charge:3V cut off 1.2V)
- Long cycle life :
More than 1,000 times charge/discharge cycle (10% D.O.D)
- Excellent over discharge characteristics

APPLICATIONS

Power supply back up use for Cellular phone, Wireless phone, PHS, Digital still Camera, PDA, MD player.

For protecting the global environment, SII developed Lithium-ion rechargeable battery which allows Pb-free reflow soldering (automatic mounting by Pb-free solder) HB414 is the Pb-free reflowable Lithium-ion rechargeable battery, by adopting highly heat resistant material and precise sealing technology.

HB series features high capacity and long cycle life with possible charging voltage range from 1.8V to 3.3V, which is most suitable for backup use of real time clock and SRAM etc.

SPECIFICATIONS

Type	Nominal Voltage (V)	Nominal Capacity (Voltage Range) (mAh)	Standard Charge Discharge Current (mA)	Cycle Life (Time)	Diameter (mm)	Height (mm)	Weight (g)
HB414	3.0	0.3 (3.0-1.2) 0.2 (2.5-1.2) 0.14 (3.0-2.0)	0.005	1000 (10% D.O.D) 100 (100% D.O.D)	4.8	1.4	0.07

REFLOW SOLDERING CONDITION

<Reflow Soldering Conditions>

Reflow soldering profile (for reference only)

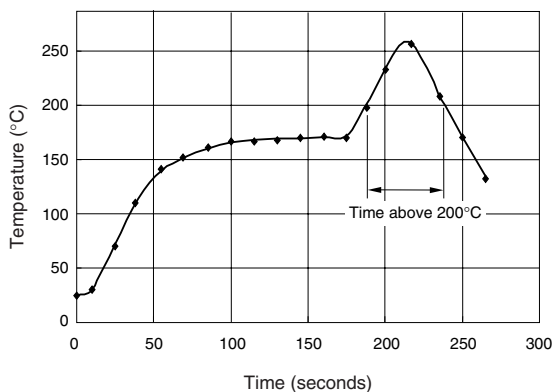

The times of repeated reflow soldering must be two times or less.
The Temperature must be measured at top of the cell.

Recommended Reflow Condition

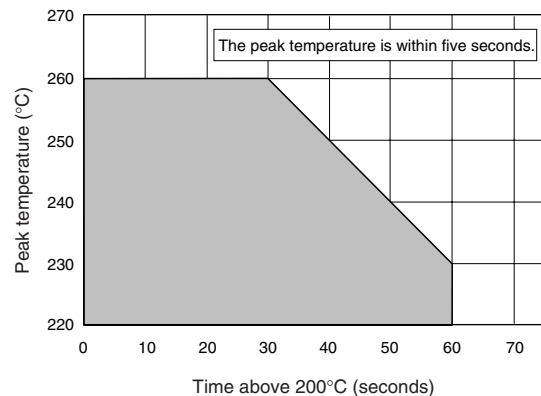

Recommended Reflow Condition

	Model	
	Peak Temperature	HB414
Max.260°C	Applicable (within 5 seconds)	

CHARACTERISTICS

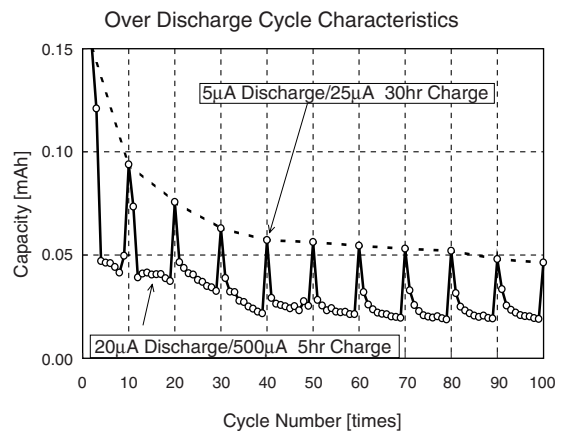
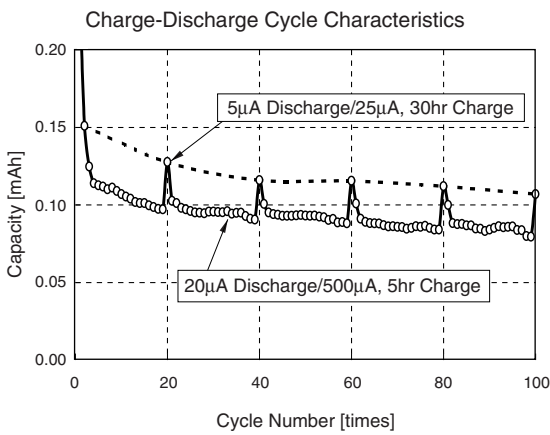
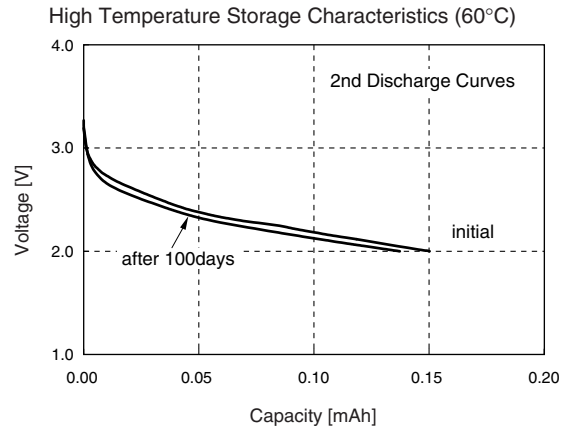
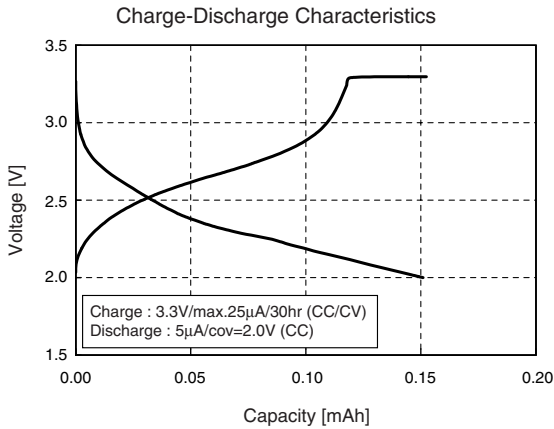

DIMENSIONS OF STANDARD TAB-WELD FOR REFLOWABLE HB BATTERY

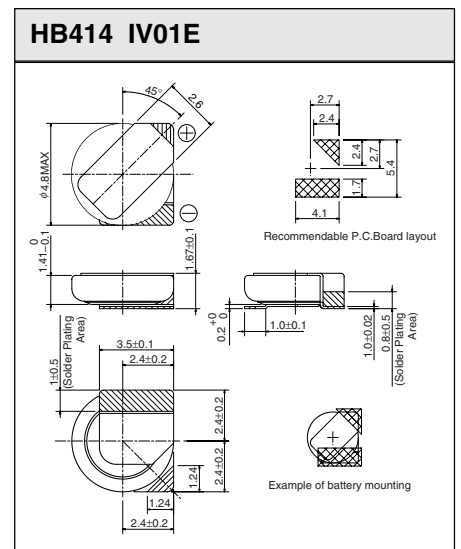
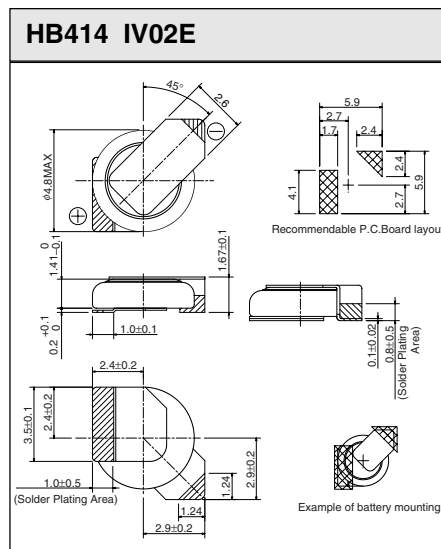
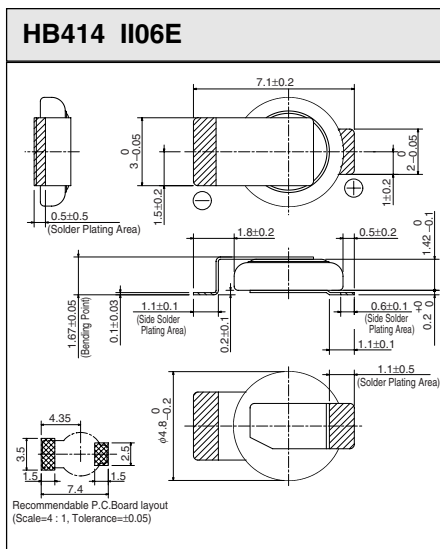

- * Hatched parts are solder plated. (E type : Sn 100%)
- * The E type is plated by Pb-free solder.
- * For any optional terminal shapes, please consult with us.
- * Unit of dimensions : mm

TS Lithium-Ion Rechargeable Battery <1.5V Type>

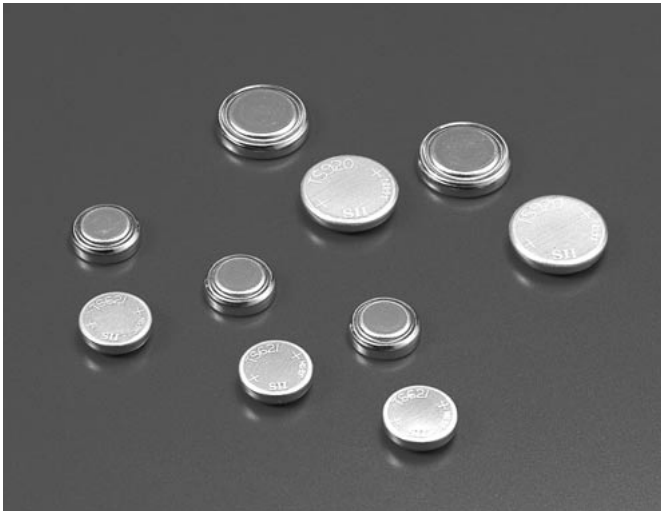

FEATURES

- Large discharge capacity:
TS obtains 15 times larger capacity to same size capacitor.
- Long cycle-life:
Realizes more than 1000 charge/discharge cycles at 20% of discharge depth.
- Excellent over-discharge characteristics:
TS maintains continuous stable characteristics after over-discharge to 0V.
- Wide charging voltage range:
TS has excellent charge-efficiency even at the charge voltage of 1.5V.
Any setting is available from 1.5V to 3.0V.
- Outstanding leakage resistance:
SII's long experienced sealing technology through silver oxide battery manufacturing for timepiece achieved the excellent leakage resistance.

TS(Titanium Silicon) Lithium-Ion battery is 1.5V type rechargeable battery features large capacity, wide charging voltage range, long cycle-life and excellent reliability with using titanium composite oxide as cathode and originally developed Litium silicon oxide as anode.

APPLICATIONS

- Power supply for backing up memory or clock in cellular phone, PHS, pagers etc.
- Combined use with solar cells (watch, calculator, blinking road-marker etc.)
- Main power source for small portable equipment.

SPECIFICATIONS

Type	Nominal Voltage (v)	Nominal Capacity (mAh)*1	Standard Charge/Discharge Current (mA)	Maximum Discharge Current (continuous) (mA)	Cycle Life(Times)*2		Size(mm)		Weight (g)
					100% D.O.D*3	20% D.O.D*4	Diameter	Height	
TS621	1.5	2.5	0.015	0.5	over 200	over 1000	6.8	2.1	0.22
TS920	1.5	5.0	0.030	1.2	over 200	over 1000	9.5	2.1	0.45

*1: at 2.3V charge *2: 100% and 20% are based on nominal capacity *3: *4: D.O.D indicates depth of discharge

For Charging Circuit Design

If the battery is charged by excessive voltage or current, it makes the battery deteriorate and may cause leakage, excessive heat, explosion or fire. Please set the circuit parameter not to exceed the regulated charging voltage and charging current written in the right column. Please consult us if you need to use different charging condition from the right column.

< Maximum Charging Current >

Charge Voltage	In case of under 1.6V	In case of 1.6 to 3.0V (When battery voltage reaches 0.7V)
TS621	3mA	0.2mA
TS920	6mA	0.4mA

CHARACTERISTICS

TS621

Charge/discharge characteristics

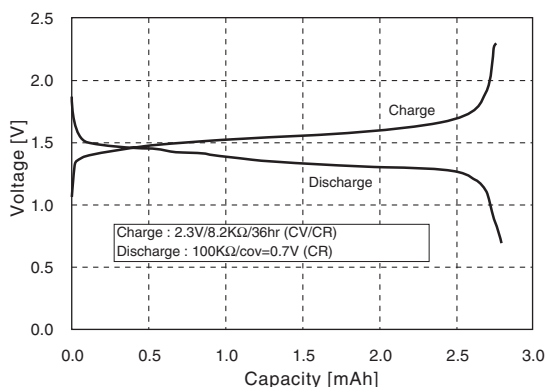

Charge voltage dependence of discharge capacity

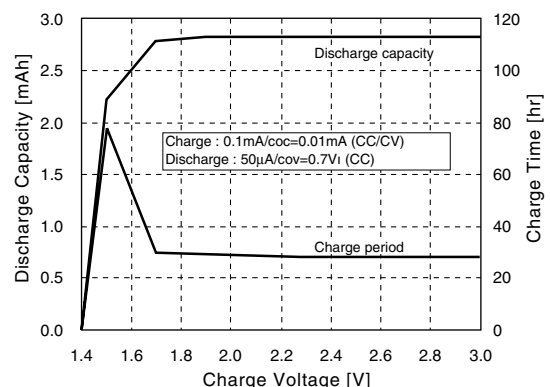

TS621

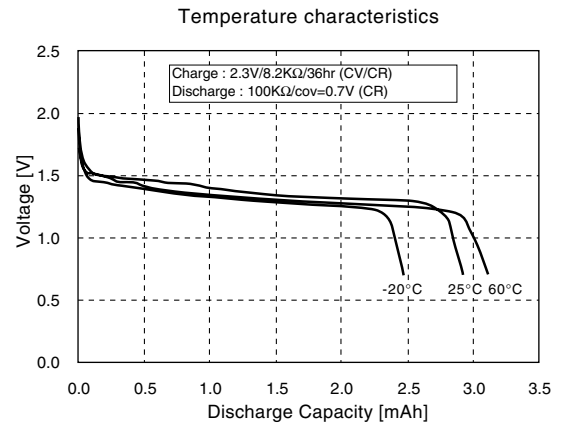
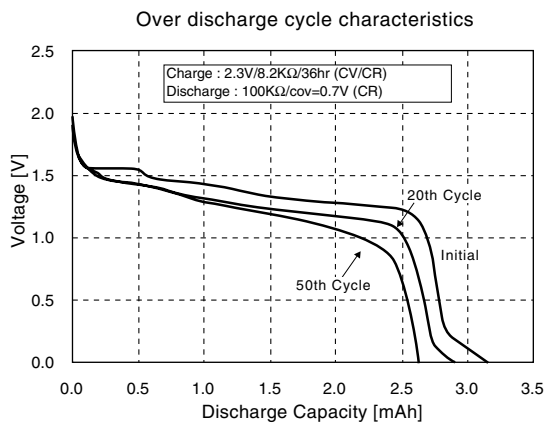
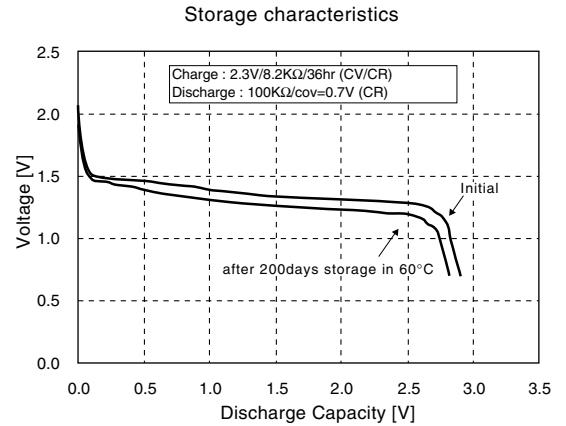
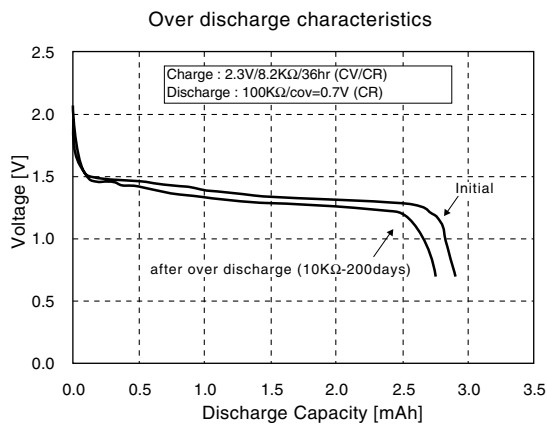
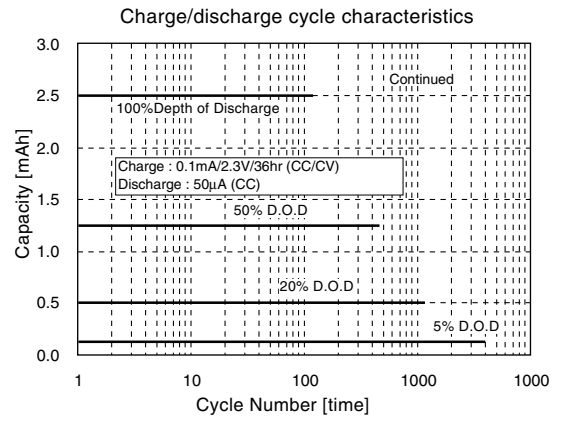
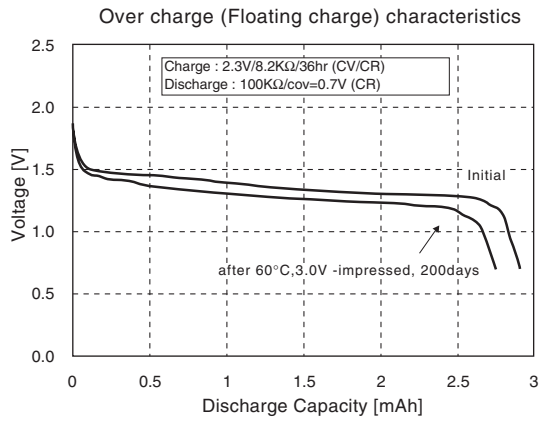

TS920

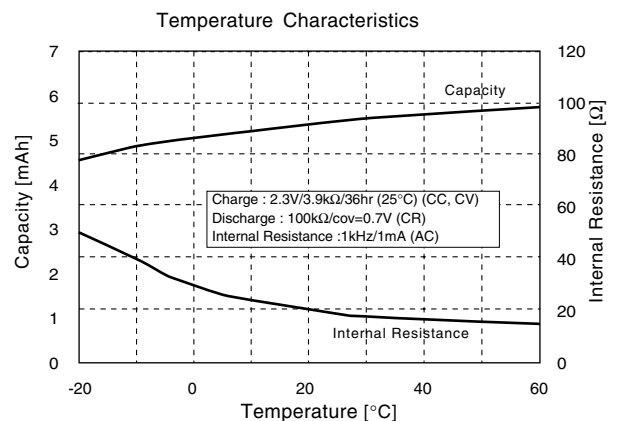
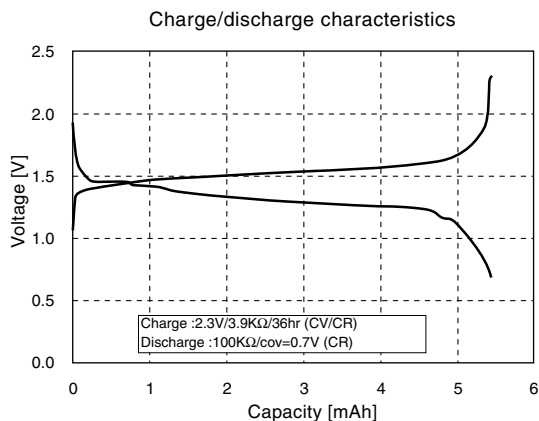

Reflowable XC Capacitor < 2.5V Rated Voltage Type >

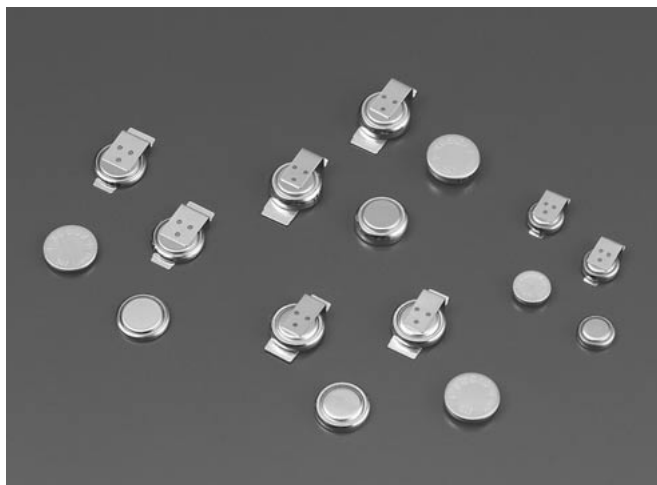

Using chemically-stable large surface area activated carbon as electrode, this new type of capacitor features high-capacitance, low-impedance, high-rated voltage, and long-term reliability through unique sealing technology. Moreover, using original heat resistant materials and cell design, the capacitor allows reflow soldering in response to the demand of automatic mounting.

FEATURES

- Able to conduct reflow soldering
- Large-capacitance
Higher-capacitance of 0.3F is available for size 621($\phi 6.8 \times 2.1\text{mm}$), compared to conventional electric double layer capacitors.
- Low-impedance & Excellent charge-discharge rate.
Impedance is less than that of conventional capacitors, and it realizes quick charge, discharge.
- High-rated voltage
2.5V rated operating voltage allows for flexible design.
- Long cycle life over 100,000times
- Excellent long-term reliability
There is no characteristic deterioration due to over-charge and overdischarge.
- Charge/discharge circuit is very simple (constant voltage charge)

APPLICATIONS

- Back up for memory and clock function, in various electronic equipments, cellular phones, cameras, PDA, Faxmachines, VTR, TV, printer, pagers, etc.
- Combined use with solar cells.
- Auxiliary power supply for voltage drop of battery.

SPECIFICATIONS

Type	Electrical Characteristics (at Room Temperature)*			Dimensions		Weight (g)
	Rated Operating Voltage (V)	Electrostatic Capacity (F)	Internal Resistance (Ω)	Diameter (mm)	Height (mm)	
XC414	2.5	0.06	60	4.8	1.4	0.06
XC609	2.5	0.07	25	6.8	0.9	0.14
XC614	2.5	0.18	25	6.8	1.4	0.16
XC621	2.5	0.30	25	6.8	2.1	0.21

*Operating Temperature Range: $-25^{\circ}\text{C} \sim +70^{\circ}\text{C}$

CHARACTERISTICS

XC414

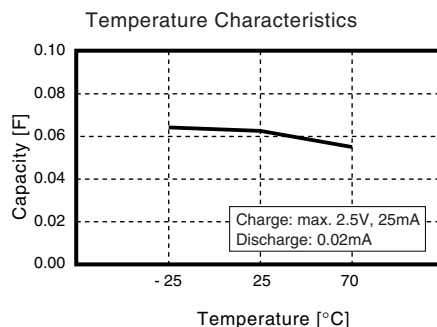
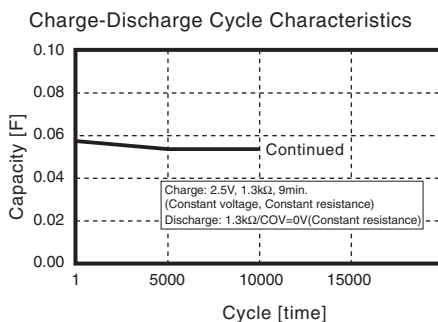
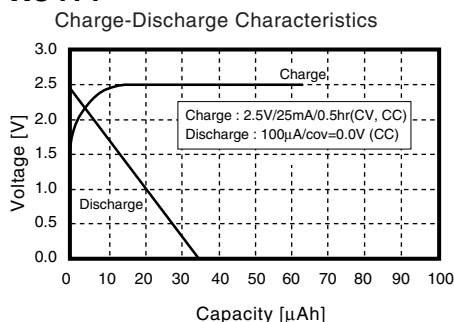

XC614

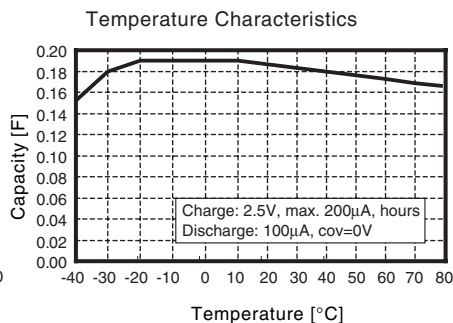
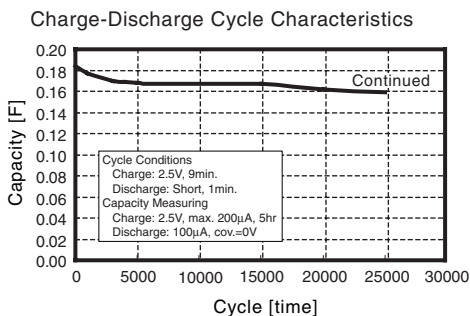
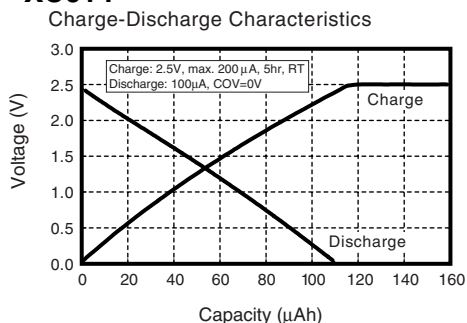

XC609

Charge Characteristics (Charge Voltage 2.5V)

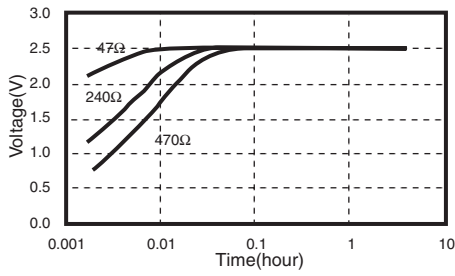

Discharge Characteristics (constant resistance)

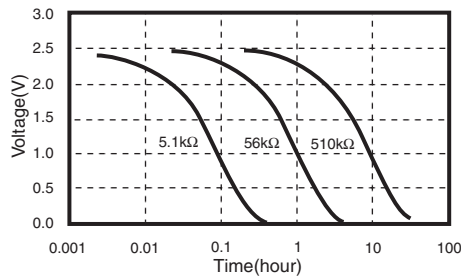

Leak Current Characteristics (Charging at 2.5V)

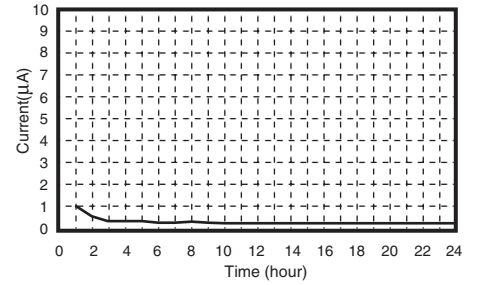

XC621

Charge Characteristics (Charge Voltage 2.5V)

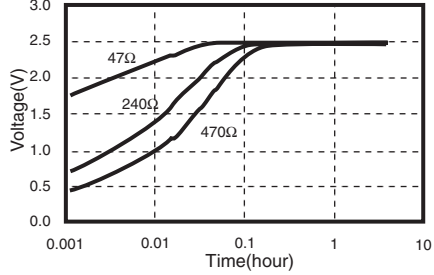

Discharge Characteristics (constant resistance)

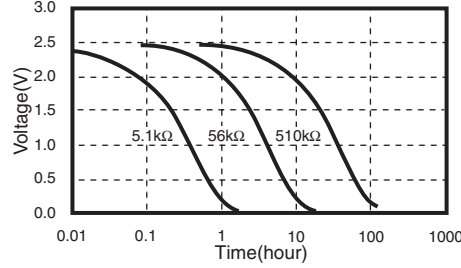

Leak Current Characteristics (Charging at 2.5V)

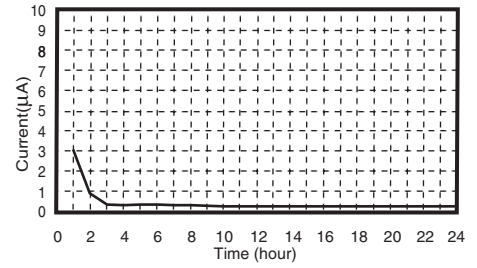

Note: Before assembly, please make sure the polarity(⊕ / ⊖) of capacitor.

REFLOW PROFILE SAMPLE

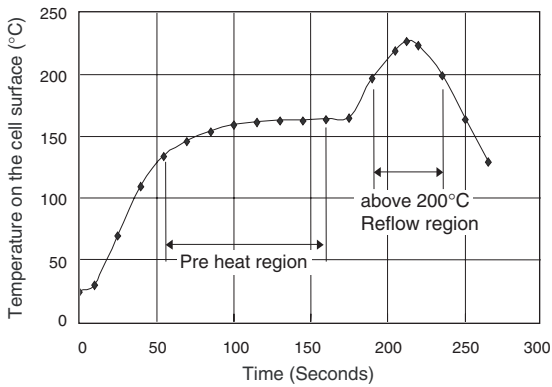

The times of repeated reflow soldering must be two times or less.
The Temperature must be measured at top of the cell.

XC414 II06N / II06E

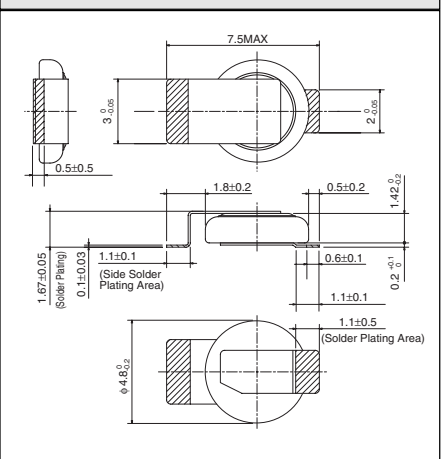

DIMENSIONS OF STANDARD TAB-WELD FOR REFLOWABLE XC CAPACITOR

XC609 II38N / II38E

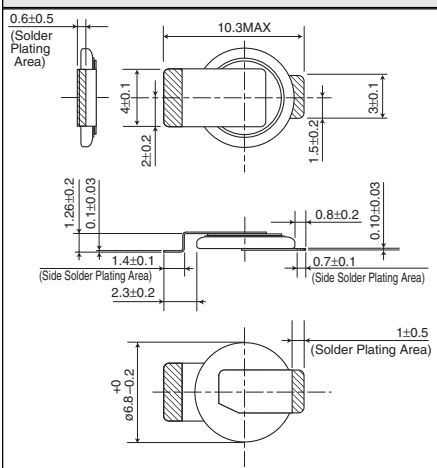

XC614 II21N / II21E

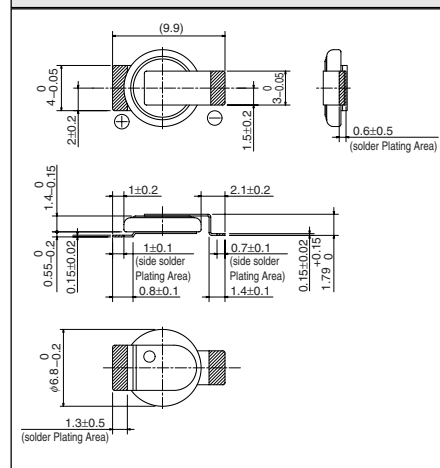

XC621 II31N / II31E

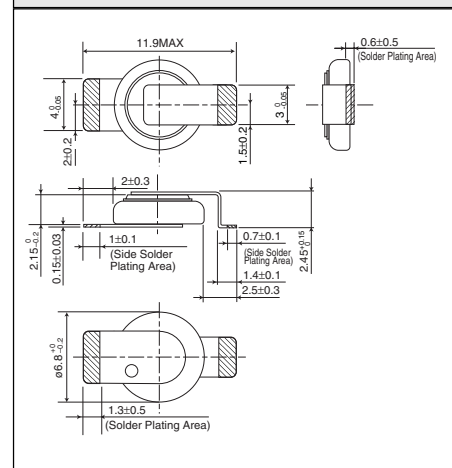

- * Hatched parts are solder plated. (N type : Pb 10% Sn 90%) (E type : Sn 100%)
- * The E type is plated by Pb-free solder. We are going to discontinue N type soon.
- * For any optional terminal shapes, please consult with us.
- * Unit of dimensions : mm

Reflowable XH Capacitor <3.3V High-rated Voltage Type>



FEATURES

- High-rated voltage : Able to be used at wide range voltage form 0V to 3.3V and be used for various applications
- Reflowable
- High Capacity : 0.07F with "414" size (diameter4.8 mm : high 1.4mm)
- Low Impedance : Quick Charge-Discharge Performance
- Long Cycle Life : More than 10,000 times charge-discharge cycle
- Able to make simple charging circuit (Constant-voltage charging)

APPLICATIONS

Power supply back up use for Cellular phone, Wireless phone, PHS, PDA, MD player

Adopting high voltage-resistant material and new design, we realize the XH unit cell that is a high voltage-resistant reflowable capacitor rated to 3.3V.

Using chemically-stable large surface area activated carbon as electrode and SII's original sealing and manufacturing technology, the XH capacitor features high-capacity, low-impedance and long-term reliability. The XH capacitor is most suitable for clock and memory backup in various electronic equipments due to its wide operating voltage.

SPECIFICATIONS

Type	Electrical Characteristics(at Room Temperature)*			Dimensions		Weight (g)
	Nominal Voltage (V)	Electrostatic Capacity (F)	Internal Resistance (Ω)	Diameter (mm)	Height (mm)	
XH414	3.3	0.07	70	4.8	1.4	0.06

*Recommended Operating Temperature Range: -25°C to +70°C

CHARACTERISTICS

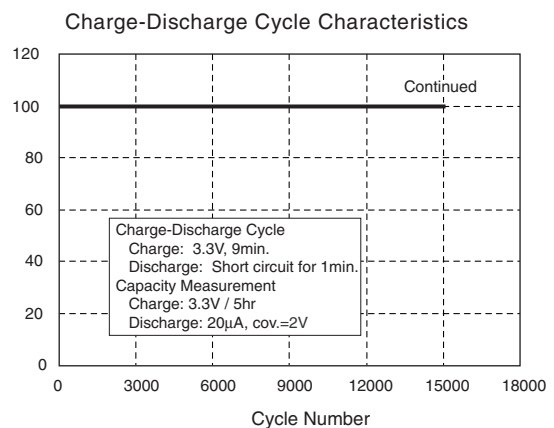
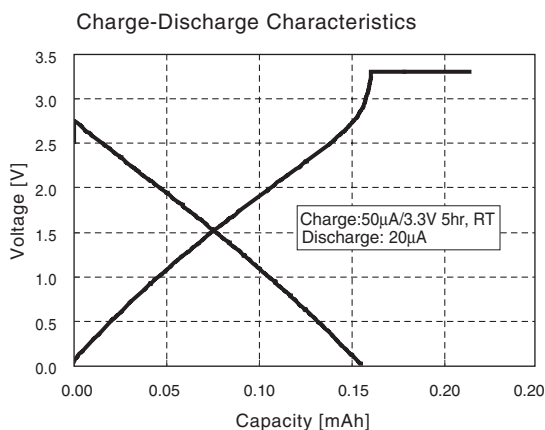

CHARACTERISTICS

Discharge Current Characteristics

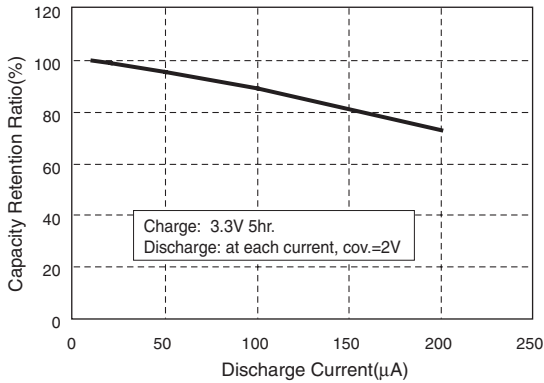

Temperature Characteristics

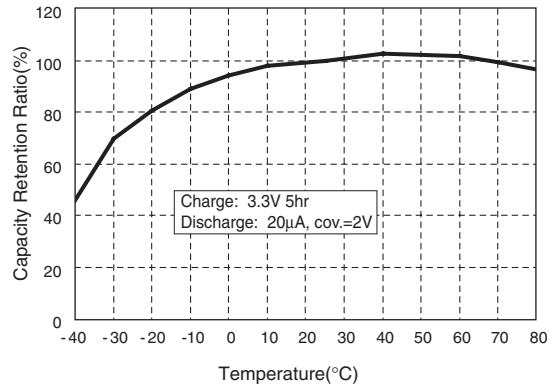

REFLOW SOLDERING CONDITION

Reflow Soldering Temperature Profile Example

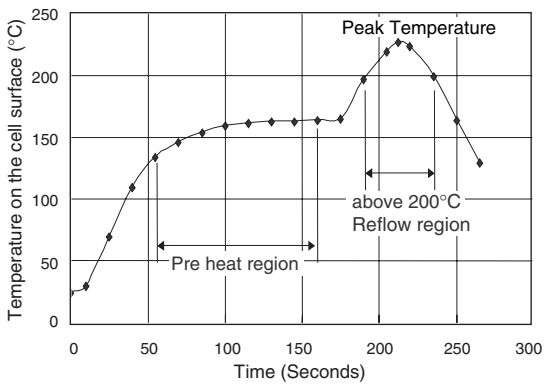

The times of repeated reflow soldering must be two times or less.
The Temperature must be measured at top of the cell.

Recommended Reflow Condition

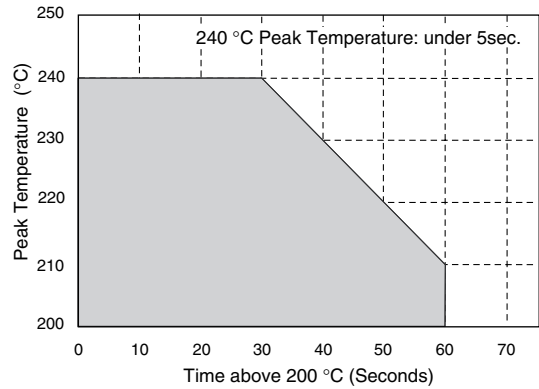

DIMENSIONS OF STANDARD TAB-WELD FOR REFLOWABLE XH CAPACITOR

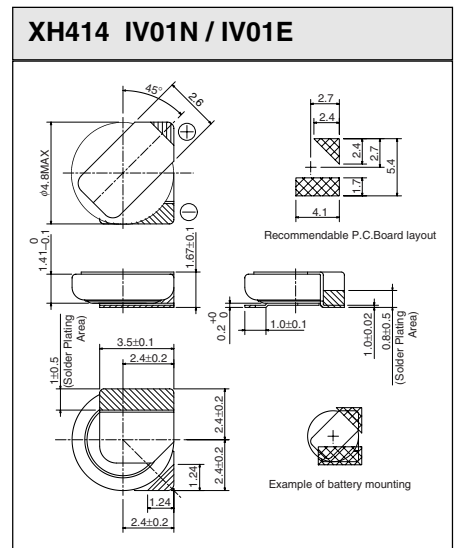
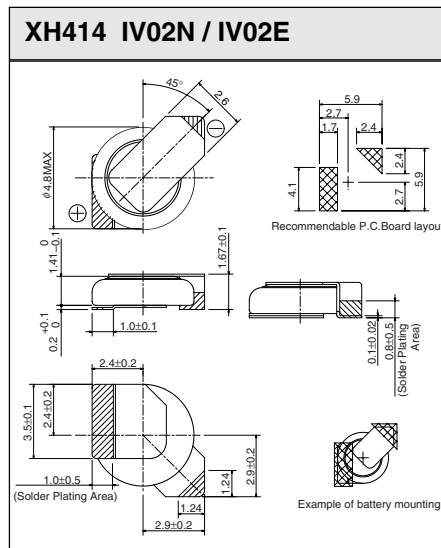
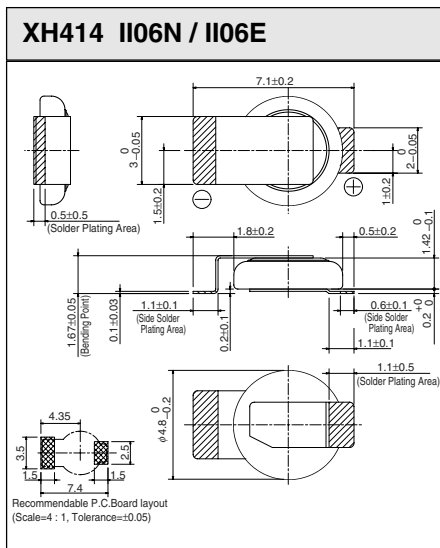

- * Hatched parts are solder plated. (N type : Pb 10% Sn 90%) (E type : Sn 100%)
- * The E type is plated by Pb-free solder. We are going to discontinue N type soon.
- * For any optional terminal shapes, please consult with us.
- * Unit of dimensions : mm

Pb-free Reflowable Capacitor XH414H <3.3V High-rated Voltage Type>

NEW



FEATURES

- Pb-free reflowable
Superior heat resistance (260°C peak) allows reflow soldering by Pb-free solder
- High-rated voltage : Able to be used at wide range voltage form 0V to 3.3V and be used for various applications
- High Capacity : 0.07F with "414" size (diameter 4.8 mm : hight 1.4mm)
- Low Impedance :
Quick Charge-Discharge Performance
- Long Cycle Life :
More than 10,000 times charge-discharge cycle
- Able to make simple charging circuit (Constant-voltage charging)

APPLICATIONS

Power supply back up use for Cellular phone, Wireless phone, PHS, PDA, MD player

For protecting the global environment, SII developed Capacitor which allows Pb-free reflow soldering (automatic mounting by Pb-free solder)

XH414H is the Pb-free reflowable Capacitor, by adopting highly heat resistant material and precise sealing technology.

The XH414H Capacitor features high-capacity, low-impedance and long term reliability.

It is most suitable for clock and memory backup in various electric equipments due to its wide operating voltage.

SPECIFICATIONS

Type	Electrical Characteristics(at Room Temperature)*			Dimensions		Weight (g)
	Nominal Voltage (V)	Electrostatic Capacity (F)	Internal Resistance (Ω)	Diameter (mm)	Height (mm)	
XH414H	3.3	0.07	70	4.8	1.4	0.07

*Recommended Operating Temperature Range: -25°C to +70°C

REFLOW SOLDERING CONDITION

<Reflow Soldering Conditions>

Reflow soldering profile (for reference only)

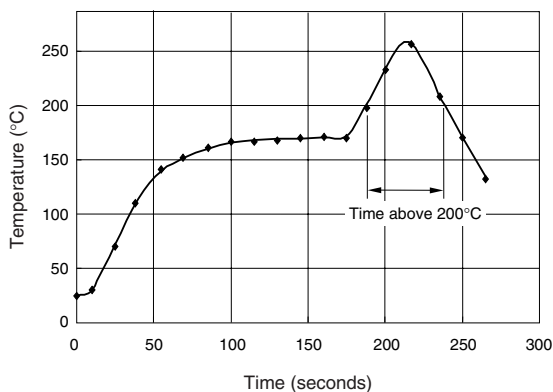

The times of repeated reflow soldering must be two times or less.
The Temperature must be measured at top of the cell.

Recommended Reflow Condition

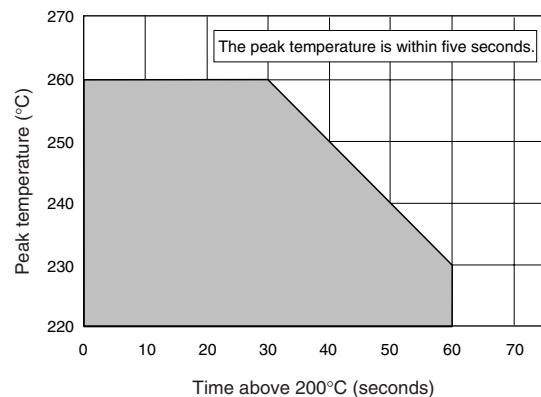

Recommended Reflow Condition

	Model	
	HB414	XH414H
Peak Temperature	HB414	XH414H
Max.260°C	Applicable (within 5 seconds)	

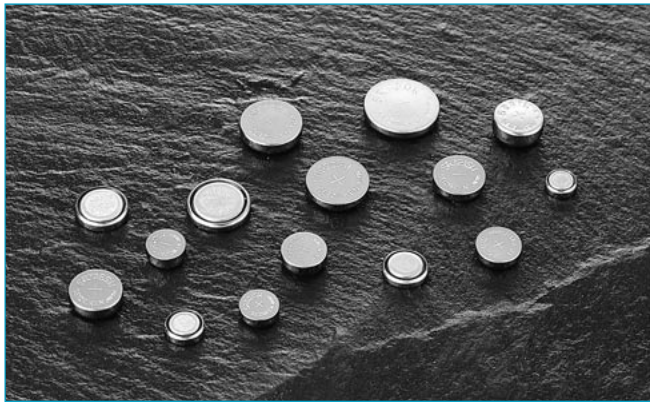

Silver oxide is used as cathode, zinc is used as anode, and sodium hydroxide solution or potassium hydroxide solution is used as electrolyte. These batteries with large capacity and stable voltage characteristics are widely applied to products demanding high accuracy, like quartz watches.

CROSS SECTION

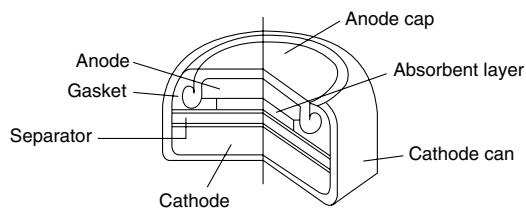

FEATURES

• Large capacity

Energy density per volume is about 2 times higher than that of alkaline-manganese batteries.

• Stable operating voltage

Operating voltage is very stable until the end of discharge.

• Excellent leakage resistance

Excellent leakage resistance is achieved by our special sealing materials and superior processing technologies.

• Excellent pulse load characteristics

Batteries using potassium hydroxide solution are most suitable for functions which consume relatively high current, such as an alarm-or-backlight-function incorporated into digital quartz watches.

• A comprehensive variety of products

The diameter is from 4.8 mm to 11.6mm, the height is from 1.2mm to 3.6mm.

Users can select the most suitable battery for their applications.

APPLICATIONS

Watches, Clocks, Calculators, Hearing aids, Digital clinical thermometers, Cameras, Electronic games, Card radios, Remote controllers.

SPECIFICATIONS

	Model No.	Electrical Characteristics (at Room Temperature)			Dimensions		Weight (g)	UCAR No.	C.C.V.*(TYP.)		Storage loss (MAX) (%/Y)		
		Nominal Voltage (V)	Nominal Capacity (mAh)	Maximum Drain (mA)	Diameter (mm)	Height (mm)			+24°C (V)	-10°C (V)			
Low Drain	SR416SW	1.55	7.5	0.8	4.80	1.65	0.12	—	1.35	1.10	7		
	SR421SW		12			2.15	0.16	—					
	SR512SW		5.5		5.80	1.25	0.14	335	1.15				
	SR516SW		12.5			1.65	0.20	317					
	SR521SW		16		2.15	0.25	379	1.10					
	SR527SW		22		2.70	0.31	319						
	SR616SW		15		6.80	1.65	0.24	321	1.45	1.20			
	SR621SW		23			2.15	0.33	364					
	SR626SW		30		2.60	0.38	377						
	SR712SW		11		7.90	1.25	0.25	346					
	SR716SW		21			1.65	0.34	315					
	SR721SW		28		2.10	0.44	362						
	SR726SW		34		2.60	0.53	397						
	SR41SW		45		3.60	0.69	384						
	SR916SW		27		9.50	1.65	0.53	373					
	SR920SW		46			2.05	0.60	371					
SR927SW	55	2.70	0.80	395									
SR1120SW	53	11.60	2.05	0.94	381								
High Drain	SR626W	1.55	28	8	6.80	2.60	0.36	376			1.35	1.05	7
	SR721W		26			2.10	0.41	361					
	SR726W		34		7.90	2.60	0.53	396			1.15		
	SR41W		45			3.60	0.69	392					
	SR920W		42		9.50	2.05	0.56	370	1.10				
	SR927W		53			2.70	0.77	399		1.05			
	SR1120W		53		11.60	2.05	0.94	391	1.40		1.20		

*C.C.V. : Closed Circuit Voltage Low Drain 2kΩ 7.8msec Pulse High Drain 200Ω 5sec.

CHARACTERISTICS

SR621SW

Load-discharge characteristics

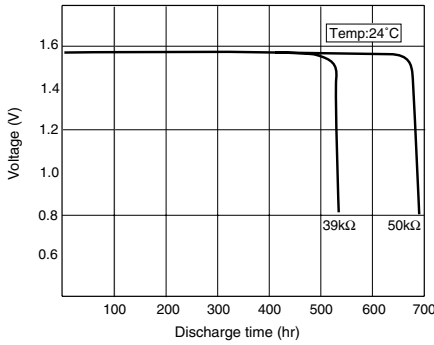

Pulse-discharge characteristics

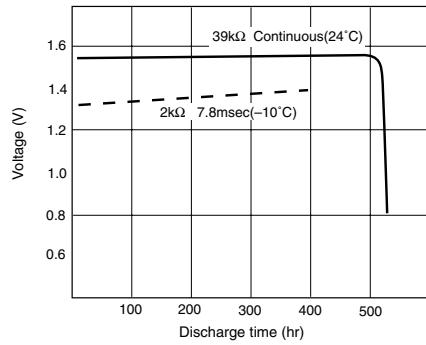

Load-temperature-voltage characteristics

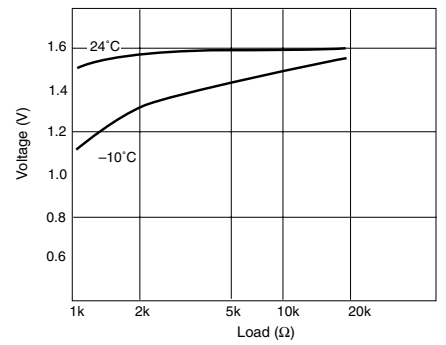

SR920SW

Load-discharge characteristics

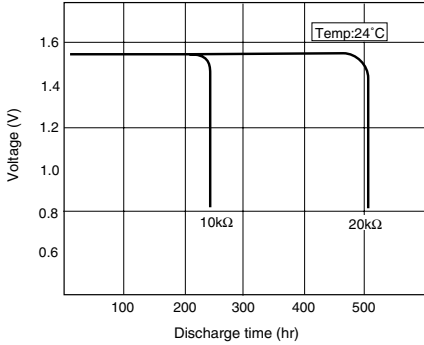

Pulse-discharge characteristics

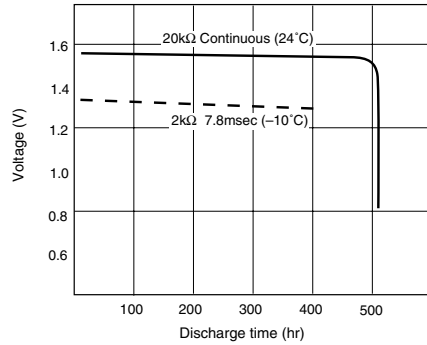

Load-temperature-voltage characteristics

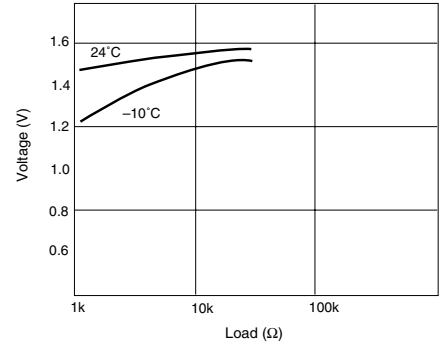

SR41W

Load-discharge characteristics

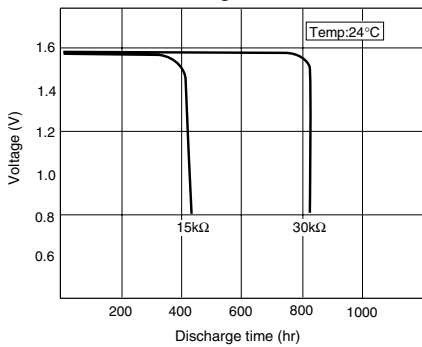

Pulse-discharge characteristics

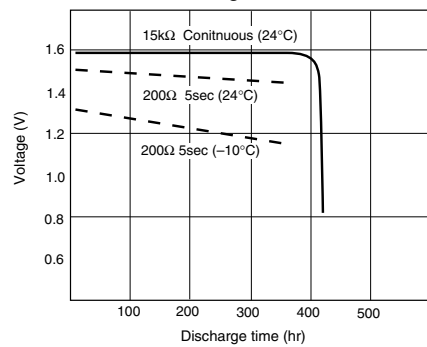

Load-temperature-voltage characteristics

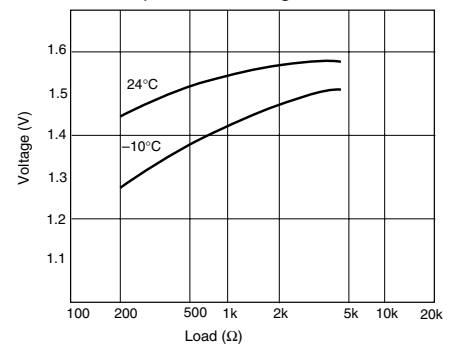

SR920W

Load-discharge characteristics

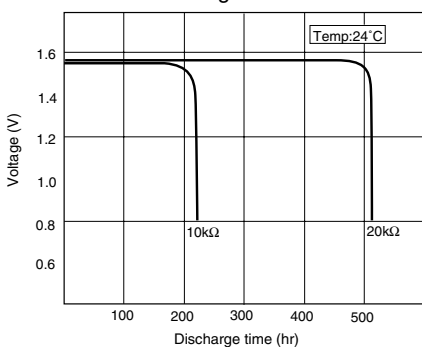

Pulse-discharge characteristics

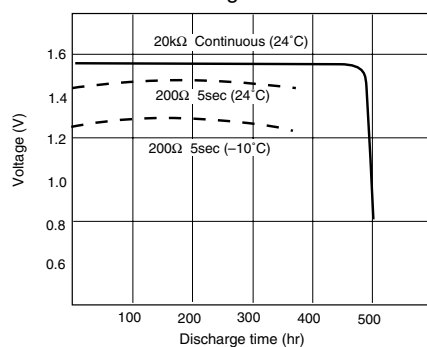

Load-temperature-voltage characteristics

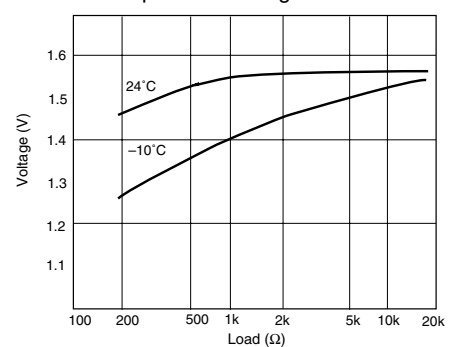

Environmental Activities at Seiko Instruments Inc. BM Business Unit

SII Group Environmental Policy :

Environmental Concept

SII is concerned about every facet of the global environment and is aiming toward a world where all living things can exist in harmony together. SII works for the protection of the environment and its continual improvement in every corporate activity.

SII BM Business Unit is implementing following actions;

(These actions are taken mainly at SII Micro Parts Ltd., the manufacturer of BM products)

1. Supply products and services that contribute to an environmental protection.

- Developing and supplying products that can endure the high-temperature reflow process, to promote the lead-free manufacturing in the market.
- Conducting environmental assessment with every battery product being designed.
- Implemented a collection of used watch and rechargeable batteries, in cooperation with Battery Association of Japan.
- Facilitating our products to meet 'SII Green Plan Product Standards' and targeting 30% of our products to acquire 'SII Green Product Label' by end of FY2004.

2. Promote Energy Saving

Saving energy in the manufacturing process;

Taking actions such as switching the source of air conditioning from electricity to gas, reducing CO2 emission despite of increasing the production efficiency.

In FY2001 CO2 emission was reduced by 23.5%, compared to the volume in FY1990.

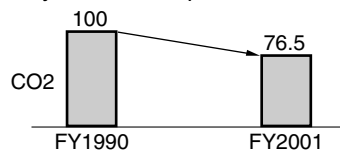

3. Zero Emissions ('No waste to emit')

Reduce and Re-use;

Promoting to abolish any toxic or dangerous material, use environment-friendly substitutes and change packaging to re-usable and recyclable material. In FY2001 the total waste disposal (including recycled) was reduced by 52.6%, compared to the volume in FY1997.

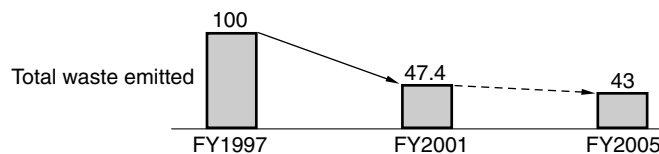

Recycling ;

Studying the best method to recycle each waste and converting to the method of more efficient, less faulty, manufacturing. In FY2001 the total disposed waste was 10 tons, reduced by 86.3%, compared to the volume in FY1997.

We are striving and taking actions continuously until we achieve 'Zero Emissions'.

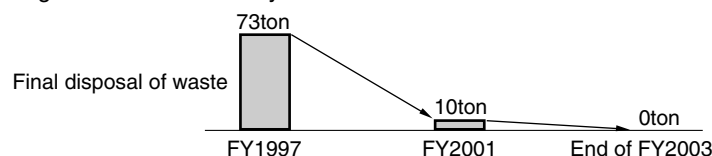

4. Green Purchase

Promoting "Green Purchase" action for manufacturing materials. To achieve this, we conduct "Suppliers Structure Audit" and "Purchased Product Audit" and will extend this action to all materials we purchase.

5. Green Life

Promoting "Green Life" actions; such as cleaning-up campaign in the neighbor area, planting greenery, stop unnecessary car-idling campaign, and so on.

Check Sheet for Selecting Micro Battery

Please use check sheet below when you select our Micro Battery for selecting the best suited battery for your use.

Fax Sheet

Seiko Instruments Inc. BM Sales Sec. 043-211-8035 Battery Sales Person

1. Your company name

2. Which application do you use?

3. Your expected backup period

hour / day / month

4. Your requested delivery

mm / yy

5. Operation voltage of the device for backup

V to V

6. Consumption current at backup time

μA • μA

7. Setting value of charging voltage

V

8. Exist of a back current protection diode

Yes • No

9. Vf characteristics of the back current protection diode(at $10\mu\text{A}$)

V

10. Resistance value of charging protection resistance

Ω

11. Limit of charging time

12. Necessary number of cycle

times

13. Other your requests

Your contact information

Name _____

Section _____

Phone _____

Fax _____

E-mail _____



SII Micro Parts Ltd. who manufactures the products described in this catalog holds the ISO-9001 quality management system certificate and the ISO-14001 environmental management system certificate.

IMPORTANT

1. The information herein is subject to change without notice.
2. Neither reproduction nor duplication of this catalog in whole or part is allowed without the prior written approval of Seiko Instruments Inc.
3. The colors of the products reproduced herein may be different from the actual colors. Check color on actual products before using the product.
4. Circuits and respective application methods described herein are for reference only. Seiko Instruments Inc. is not responsible for any and all infringement or damages to the rights of third parties (including industrial properties) caused by the use of circuits or application methods herein. Seiko Instruments Inc. shall not license any industrial properties owned by Seiko Instruments Inc. or any third party through this catalog.
5. When products described herein include Strategic Products (or Services) stipulated in the Foreign Exchange and Trade Control Law, they shall not be exported without permission of governmental authorities.
6. The products described herein are designed for consumer equipment and cannot be used as part of any device or equipment which influences the human body or requires a significantly high reliability, such as physical exercise equipment, medical equipment, disaster prevention equipment, gas related equipment, vehicles, aircraft and equipment mounted on vehicles.



www.sii.co.jp/compo

Seiko Instruments Inc.

Network Components Business Unit
1-8, Nakase, Mihama-ku, Chiba-shi, Chiba 261-8507, Japan
Telephone :+81-43-211-1205 Facsimile :+81-43-211-8035
E-mail:component@sii.co.jp

Seiko Instruments USA Inc.

Electronic Components Div.
2990 W. Lomita Blvd., Torrance, CA 90505, U.S.A.
Telephone :+1-800-934-9334 Facsimile :+1-909-975-5699
E-mail :seiko-eed@salesupport.com
<http://www.seiko-usa-eed.com>

Seiko Instruments GmbH

Siemensstraße 9, D-63263 Neu-Isenburg, Germany
Telephone :+49-6102-297-0 Facsimile :+49-6102-297-320
E-mail :info@seiko-instruments.de
<http://www.seiko-instruments.de>

Seiko Instruments France S.A.R.L.

55, Rue d' Aguesseau, 92774, Boulogne Billancourt, Cedex, France
Telephone :+33-1-41-31-71-30 Facsimile :+33-1-41-31-71-39
E-mail :info@seiko-instruments.fr
<http://www.seiko-instruments.fr>

Seiko Instruments (H.K.) Ltd.

4-5 / F, Wyler Centre 2,200 Tai Lin Pai Road, Kwai Chung,
N.T., Kowloon, Hong Kong
Telephone :+852-2421-8611 Facsimile :+852-2480-5479
E-mail :sales@sih.com.hk
<http://www.sih.com.hk>

Seiko Instruments Taiwan Inc.

4FL, No.40, Sec. 2, Min-Chuan E. Rd., Taipei 104, Taiwan, R.O.C.
Telephone :+886-2-2563-5001 Facsimile :+886-2-2521-9519
E-mail :public@sii.co.jp
<http://www.sii.com.tw>

Seiko Instruments Singapore Pte. Ltd.

2, Marsiling Lane, Woodlands New Town, Singapore 739144
Telephone :+65-6269-1370 Facsimile :+65-6269-9729
<http://www.sii.com.sg>

(Specification are subject to change without notice.)

Released in Oct. 2002

No. CAB0210EJ0055-10/C



printed on 100% recycled paper and with soy ink.